





 **GABE**[®]
TAPIZADOS
Mucho más que confort

Since 1968



ÍNDICE/INDEX

AGADIR	Pág 04-09	NEOS	Pág 44-47
ARIANNE	Pág 10-15	PORTOFINO	Pág 48-51
BRASILIA	Pág 16-19	 ROMA FONDO REDUCIDO 83 cm REDUCED DEPTH	Pág 52-57
CLOUD	Pág 20-23	 SAMOA FONDO REDUCIDO 85 cm REDUCED DEPTH	Pág 58-61
KAZAN	Pág 24-29	SIDNEY	Pág 62-65
KYOTO	Pág 30-33	TEXAS	Pág 66-69
LUCCA	Pág 34-37	XIAN	Pág 70-75
MISTRÁ	Pág 38-43		





Mucho más que Confort
Much more than Comfort



Nuestra Historia

GABE Sofás es una empresa dedicada a la fabricación y venta de muebles tapizados, está localizada en Écija (Sevilla, España), fue fundada en el año 1968 por D. José García Martín, pionero en la industria del mueble, en la que empezó hace más de 50 años fabricando lámparas y muebles auxiliares, en la que posteriormente se centró en la fabricación de muebles tapizados.

La trayectoria seguida por la empresa junto a una política de servicio y calidad al mejor precio ha hecho que GABE Tapizados sea una empresa referente en su sector, contando con una red comercial muy amplia, nuestro mercado se encuentra repartido por todo el territorio nacional y una parte de su producción se destina a la exportación, la cual se encuentra en plena expansión.

Our history

GABE Sofás is a company dedicated to the manufacture and sale of upholstered furniture, it is located in Écija (Seville, Spain), it was founded in 1968 by D. José García Martín, a pioneer in the furniture industry, where it started more than 50 years manufacturing lamps and auxiliary furniture, in which he later focused on the manufacture of upholstered furniture.

The trajectory followed by the company together with a service and quality policy at the best price has made GABE Sofás a leading company in its sector, with a very wide commercial network, our market is spread throughout the national territory and a part of its production is destined for export, which is in full expansion.



Proceso de fabricación segura

Los productos de nuestra empresa están sometidos a altos niveles de temperatura (+120 °C) en nuestro proceso de fabricación, facilitando así la eliminación de virus y bacterias.

Nuestra misión como empresa es poder ofrecer la tranquilidad a nuestros clientes, haciendo que todo nuestro proceso de fabricación esté sometido a las más rigurosas medidas de seguridad desde el tratamiento de las materias primas hasta la entrega.

Our history

The products of our company are subjected to high temperature levels (+248 °F) in our manufacturing process, facilitating the elimination of viruses and bacteria.

Our mission as a company is to be able to offer our clients peace of mind, ensuring that our entire manufacturing process is subject to the most rigorous security measures from the treatment of raw materials to delivery.



Tecnología y desarrollo

Nuestra empresa ha conjugado la labor artesanal con la aplicación de mejoras tecnológicas, disponemos

de un departamento de diseño y desarrollo de nuevos productos, un gabinete de trabajo para la selección de telas y acabados, además contamos con un moderno sistema de patronaje por ordenador que mejora y optimiza las operaciones de corte, siempre intentando satisfacer al cliente más exigente.

Contamos con unas instalaciones de más de 4.000 m², y con 35 profesionales de probada experiencia en el sector del mueble tapizado, perfectamente formados en el manejo de la maquinaria y herramientas para dichos productos que saben dar el perfecto acabado que distingue a nuestra empresa.

Contamos con flota de vehículos propios y autónomos con lo que cubrimos las necesidades de pequeñas y grandes superficies de venta, y modernos camiones expositores los cuales visitan todos nuestros clientes con el fin de presentar novedades de nuestros productos y también recibir las sugerencias que nos demanden.

Nuestros muebles están realizados con materiales de las mejores calidades, tanto en aquellas zonas visibles como en otras donde no lo son, ya que en Gabe cuidamos hasta el último detalle para que nuestros clientes estén satisfechos con nuestros productos.

Gabe Sofás cuenta con un extensa red de tiendas de muebles y especialistas en descanso que distribuyen nuestros productos y garantiza la completa satisfacción del consumidor final. En nuestros distribuidores encontrarás el asesoramiento que necesitas a la hora de pegar el último empujón a la decoración de tu casa.

Technology and development

Our company has combined artisan work with the application of technological improvements, we have

From a department of design and development of new products, a work cabinet for the selection of fabrics and finishes, we also have a modern computer patterning system that improves and optimizes cutting operations, always trying to satisfy the most demanding customer.

We have facilities of more than 4,000 m², and 35 professionals with proven experience in the upholstered furniture sector, perfectly trained in the handling of machinery and tools for these products who know how to give the perfect finish that distinguishes our company.

We have our own and autonomous vehicle fleet with which we cover the needs of small and large sales areas, and modern display trucks that all our clients visit in order to present news of our products and also receive the suggestions that they demand.

Our furniture is made with materials of the best qualities, both in those visible areas and in others where they are not, since at Gabe we take care of every last detail so that our customers are satisfied with our products.

Gabe Sofás has an extensive network of furniture stores and rest specialists who distribute our products and guarantee complete satisfaction of the final consumer. In our distributors you will find the advice you need when it comes to giving the last push to decorating your home.





MOD.
AGADIR





CARACTERÍSTICAS / CHARACTERISTICS

TABLA DE PUNTOS / TABLE OF POINTS

COMPOSICIONES / COMPOSITIONS

RESPALDOS / Back

Fibra acrílica termoligante 100%.
100% thermoligating acrylic fiber.

RECUBRIMIENTO ESTRUCTURA / Structure coating

Espuma de Poliuretano de 20 Kg/m³.
Foam rubber 20 kg/m³.

SUSPENSIÓN / Suspensión

Bastidor de muelle zig-zag.
Zig-zag spring frame.

ASIENTOS / Seats

Espuma de poliuretano 35 kg/m³ + 5 cm. supersoft.
Foam rubber 35 kg/m³ + super soft 5 cm.

BRAZOS / Arms

Estándar 15 cm.
Standard 15 cm.

DESENFUNDABLE / Removable loose covers

Respaldos, asientos, cojines decoración.
Backrest, seats, decoration cushions

MEDIDAS / Seat

Expresadas en cm. (+/- 5 cm.)
In centimetres (+/- 5 cm.)

PIE / Leg

Aguja color níquel o brown.
Nickel or brown colored needle.

Denisse collection 1	Urban collection 2	Grupo 3 Group 3	Grupo 4 Group 4	Grupo 5 Group 5	Grupo 6 Group 6
----------------------	--------------------	-----------------	-----------------	-----------------	-----------------

COMPOSICIONES / COMPOSITIONS						
Comp. Chaise 285 x 170 cm. / 285 x 170 cm. Chaise composition	875	902	930	973	1016	1042
Módulo Chaiselongue 100 x 170 cm. / 100 x 170 cm. Chaise module	388	398	407	422	434	439
Sofá Maxi 330 cm. 3 módulos / 330 cm. maxi sofa 3 modules	802	834	865	916	935	948
Sofá Maxi 285 cm. 3 módulos / 285 cm. maxi sofa 3 modules	742	770	800	845	888	915
Sofá Maxi 240 cm. 3 módulos / 240 cm. maxi sofa 3 modules	679	708	732	773	812	841
Sofá 230 cm. / 230 cm. 2 module sofa	549	572	595	633	644	652
Sofá 200 cm. / 200 cm. 2 module sofa	511	532	553	587	614	625
Sofá 170 cm. / 170 cm. 2 module sofa	471	492	509	540	564	576
Módulo 1 plaza 1 brazo 115 cm. / 115 cm. module 1 seat 1 arm	275	286	297	316	322	326
Módulo 1 plaza 1 brazo 100 cm. / 100 cm. module 1 seat 1 arm	256	266	276	294	307	313
Módulo 1 plaza 1 brazo 85 cm. / 85 cm. module 1 seat 1 arm	236	246	255	270	282	288
Módulo 1 plaza sin brazo 100 cm. / 100 cm. Module 1 seat without arm	253	262	271	283	291	296
Módulo 1 plaza sin brazo 85 cm. / 85 cm. Module 1 seat without arm	231	238	247	257	275	290
Módulo 1 plaza sin brazo 70 cm. / 70 cm. Module 1 seat without arm	208	216	223	234	248	265
Módulo rincón / Corner module	345	355	366	386	396	407
Pouffs Terminal 102 x 60 cm. / 102 x 60 cm. pouffs	132	139	156	171	178	188
Pouffs 85 x 60 cm. / 85 x 60 cm. pouffs	121	126	142	152	161	176
Pouffs 70 x 60 cm. / 70 x 60 cm. pouffs	114	118	132	143	153	167

VALORACIÓN PUNTOS NETOS.
VALUATION NET POINTS.

MEDIDAS / MEASUREMENTS

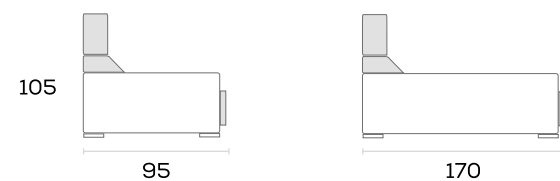

Comp. Chaise 285 x 170 cm.
285 x 170 cm. Chaise Composition

Módulo Chaise 100 x 170 cm.
100 x 170 cm. Chaise Module

Medidas en centímetros
(+/- 5 cm.)
Measurements in centimetres
(+/- 5 cm.)

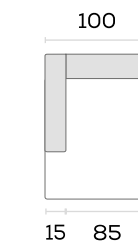
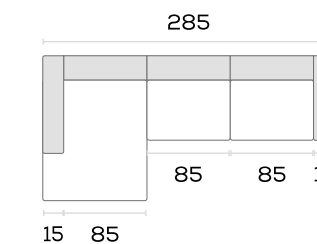

Sofá Maxi 330 cm.
330 cm. Maxi sofa

Sofá Maxi 285 cm.
285 cm. Maxi sofa

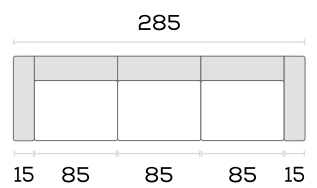

Sofá Maxi 240 cm.
240 cm. Maxi sofa

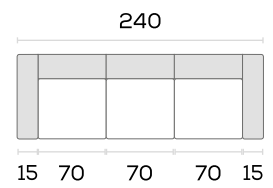

Sofá 230 cm.
Sofa 230 cm.

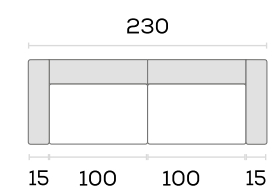

Sofá 200 cm.
Sofa 200 cm.

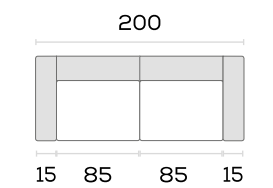

Sofá 170 cm.
Sofa 170 cm.

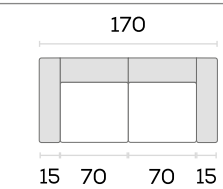

Módulo 1 plaza 1 brazo 115 cm.
115 cm. Module 1 seat 1 arm

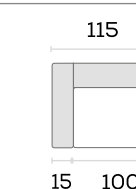

Módulo 1 plaza 1 brazo 100 cm.
100 cm. Module 1 seat 1 arm

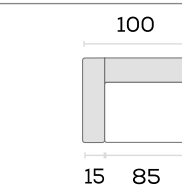

Módulo 1 plaza 1 brazo 85 cm.
85 cm. Module 1 seat 1 arm

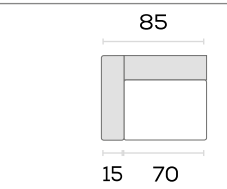

Módulo rincón
Corner module

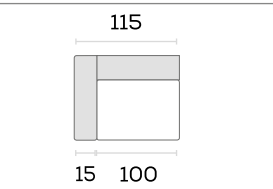

Módulo 1 plaza 100 cm.
100 cm. Module 1 seat

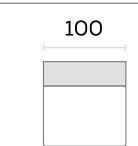

Módulo 1 plaza 85 cm.
85 cm. Module 1 seat

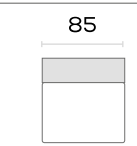

Módulo 1 plaza 70 cm.
70 cm. Module 1 seat

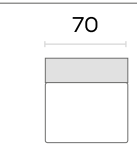

Pouffs Terminal 95 x 60 cm.
95 x 60 cm Terminal Pouffs

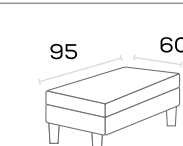

Pouffs 85 x 60 cm.
85 x 60 cm. Pouffs

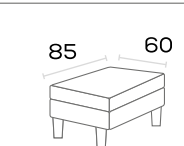

Pouffs 70 x 60 cm.
70 x 60 cm. Pouffs

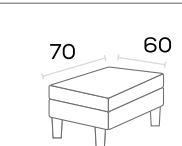



MOD.
ARIANNE



GABE
TAPIZADOS
Mucho más que confort





CARACTERÍSTICAS / CHARACTERISTICS

ESTRUCTURA / Structure

Madera de pino Macizo 25 mm. / Tablero partículas DM.

Solid pine 25 mm. / MDF.

SUSPENSIÓN / Suspensión

Bastidor de muelle zig-zag.

Zig-zag spring frame.

RESPALDOS Y BRAZOS / Backs and arms

Espuma de poliuretano súper suave recubierta de fibra acrílica.

Super soft fiber-coated polyurethane foam acrylic.

DESENFUNDABLE / Removable loose covers

Asientos, brazos y respaldos / Asiento chaiselongue NO desenfundable.

Seats, arms and backs. Chaiselongue seat without removable covers.

RECUBRIMIENTO ESTRUCTURA / Structure coating

Espuma de poliuretano de 20 kg/m³ recubierta de fibra acrílica.

Foam rubber 20 kg/m³. Acrylic fibre cover.

ASIENTO / Seat

Espuma de poliuretano 35 kg/m³ + 5 cm. supersoft recubierta de fibra acrílica.

Foam rubber 33 kg/m³ + 5 cm. super soft acrylic fibre cover.

MECANISMO / Mechanism

Relax motorizado.

Motorised relax.

Este modelo solo se fabrica en relax.
This model is only manufactured relax.



MOD.
ARIANNE

TABLA DE PUNTOS / TABLE OF POINTS

Denisse collection 1	Urban collection 2	Grupo 3 Group 3	Grupo 4 Group 4	Grupo 5 Group 5	Grupo 6 Group 6
----------------------	--------------------	-----------------	-----------------	-----------------	-----------------

COMPOSICIONES / COMPOSITIONS						
Comp. Chaise 284 x 170 cm. / 284 x 170 cm. Chaise composition	1052	1079	1130	1158	1233	1281
Comp. Chaise 236 x 170 cm. / 236 x 170 cm. Chaise composition	1008	1035	1087	1114	1189	1237
Sofá Maxi 314/3 relax / 314 cm. Maxi sofa 3 relax	1221	1250	1329	1354	1441	1492
Sofá Maxi 284/3 asientos / 284 cm. Maxi sofa 3 seats	1122	1151	1230	1252	1341	1393
Sofá Maxi 236/3 relax / 236 cm. Maxi sofa 3 relax	1079	1108	1187	1209	1298	1350
Sofá 226 cm. 2 relax / Sofa 226 cm. 2 relax	886	902	964	976	1036	1072
Sofá 206 cm. 2 relax / 220 cm. sofa 2 relax	804	820	882	894	954	990
Sofá 174 cm. 2 relax / 220 cm. 2 relax	774	790	852	864	924	960

MÓDULOS INDIVIDUALES / INDIVIDUAL UNITS						
Módulo Chaise 103 x 170 cm. / 103 x 170 cm. Chaise module	332	338	341	353	369	383
Módulo Chaise 87 x 170 cm. / 87 x 170 cm. Chaise module	316	322	326	337	353	367
Módulo 1 plaza 1 brazo 1 relax 113 cm. / 113 cm. Module 1 seat 1 arm 1 relax	443	451	482	488	518	536
Módulo 1 plaza 1 brazo 1 relax 103 cm. / 103 cm. Module 1 seat 1 arm 1 relax	402	410	441	447	477	495
Módulo 1 plaza 1 brazo 1 relax 87 cm. / 87 cm. Module 1 seat 1 arm 1 relax	387	395	426	432	462	480
Módulo 1 plaza sin brazo 1 relax 88 cm. / 88 cm. Module 1 seat without arm 1 relax	335	348	365	378	405	420
Módulo 1 plaza sin brazo 1 relax 78 cm. / 78 cm. Module 1 seat without arm 1 relax	318	331	348	358	387	403
Módulo 1 plaza sin brazo 1 relax 62 cm. / 62 cm. Module 1 seat without arm 1 relax	305	318	335	345	374	390

VALORACIÓN PUNTOS NETOS.
VALUATION NET POINTS.

MEDIDAS / MEASUREMENTS

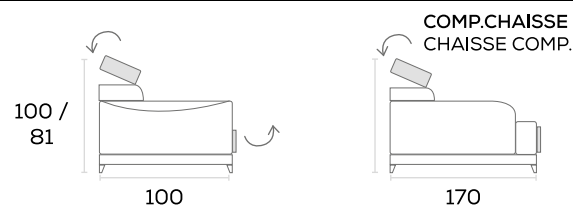

COMPOSICIONES / COMPOSITIONS

Comp. Chaise 284 x 170 cm. 284 x 170 cm. Chaise Composition	Comp. Chaise 236 x 170 cm. 236 x 170 cm. Chaise Composition	Módulo Chaise 103 x 170 cm. 103 x 170 cm. Chaise module	Módulo Chaise 87 x 170 cm. 87 x 170 cm. Chaise module
---	---	---	---

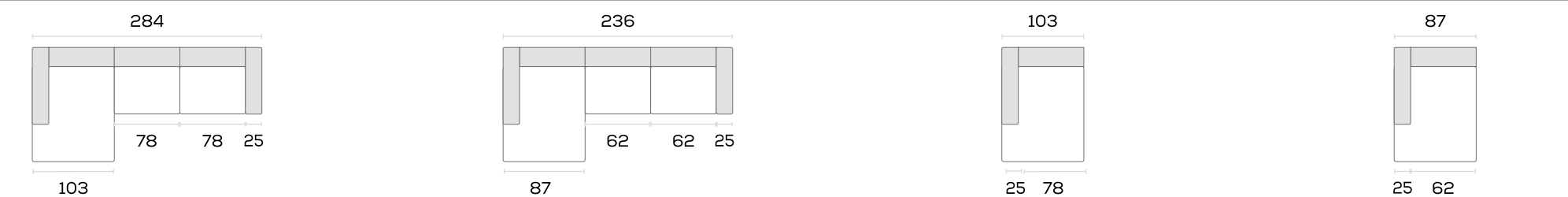

Sofá Maxi 314 cm. 314 cm. Maxi sofa	Sofá Maxi 284 cm. 284 cm. Maxi sofa	Sofá Maxi 236 cm. 236 cm. Maxi sofa	Sofá 226 cm. 226 cm. Sofa	Sofá 206 cm. 206 cm. Sofa	Sofá 174 cm. 174 cm. Sofa
-------------------------------------	-------------------------------------	-------------------------------------	---------------------------	---------------------------	---------------------------

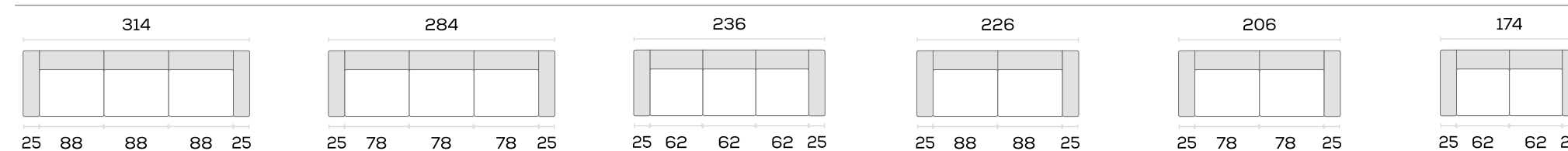

MÓDULOS / UNITS

Módulo 1 plaza 1 brazo 113 cm. 113 cm. Module 1 seat 1 arm	Módulo 1 plaza 1 brazo 103 cm. 103 cm. Module 1 seat 1 arm	Módulo 1 plaza 1 brazo 87 cm. 87 cm. Module 1 seat 1 arm	Módulo 1 plaza 88 cm. 88 cm. Module 1 seat	Módulo 1 plaza 78 cm. 78 cm. Module 1 seat	Módulo 1 plaza 62 cm. 62 cm. Module 1 seat
--	--	--	--	--	--

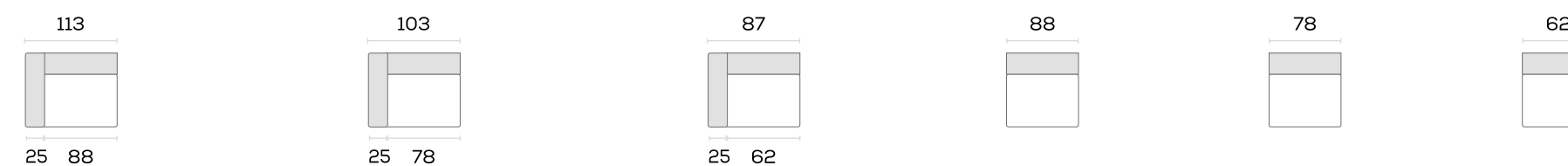

Medidas en centímetros (+/- 5 cm.)
Measurements in centimetres (+/- 5 cm.)



MOD.
BRASILIA





MOD.
BRASILIA

CARACTERÍSTICAS / CHARACTERISTICS

ESTRUCTURA / Structure
Madera pino macizo 25 mm. / tablero de partículas DM.
Solid pine 25 mm. / MDF.

SUSPENSIÓN / Suspension
Bastidor de muelle.
Zig-zag spring frame.

RESPALDOS / Backs
Fibra de poliéster ahuecada y siliconada antialérgica de alta recuperación.
Hollow siliconised polyester fibre, hypoallergenic and high recovery.

DESENFUNDABLE / Removable loose covers
Asientos, brazos y respaldos / Asiento chaisse-longue NO desenfundable.
Seats, arms and backs. Chaisse-longue seat without removable covers.

ASIENTO / Seat
espuma de poliuretano de 35 kg/m³ + 5 cm súper soft recubierta de fibra acrílica.
Foam rubber 20kg/m³ + 5 cm súper soft . Acrylic fibre cover.

RECUBRIMIENTO ESTRUCTURA / Structure coating
Espuma de poliuretano 20kg/m³
Foam rubber 20 kg/m³. Acrylic fibre cover.

BRAZOS / Arms
fibra de poliéster ahuecada y siliconada antialérgica de alta recuperación.
Hollow siliconised polyester fibre, hypoallergenic and high recovery.

MECANISMO / Mechanism
Relax motorizado, arcón pistón de gas.
Motorised relax gas piston chest.

Cabezales reclinables.
reclining heads.
Brazo almohada multiposición con arcón y puff.
Multi-position pillow arm with chest and puf.

TABLA DE PUNTOS / TABLE OF POINTS

COMPOSICIONES / COMPOSITIONS	Denisse collection 1	Urban coleccion 2	Grupo 3 Group 3	Grupo 4 Group 4	Grupo 5 Group 5	Grupo 6 Group 6
Comp. Chaise 300 x 170 cm. brazo puff arcón 300 x 170 cm. Chaise composition arm puff chest	1016	1048	1090	1139	1172	1235
Comp. Chaise 250 x 170 cm. brazo puff arcón 250 x 170 cm. Chaise composition arm puff chest	995	1023	1064	1113	1146	1209
Sofá Maxi 300 cm. 3 relax/2 brazos arcón puffs 300 cm. 3 relax/ 2 arms chest puffs	1132	1145	1173	1219	1254	1312
Sofá Maxi 250 cm. 3 relax/2 brazos arcón puffs 250 cm. 3 relax/ 2 arms chest puffs	1120	1137	1148	1194	1229	1287
Sofá 220 cm. 3 plazas/2 relax/2 brazos arcón puffs 220 cm. 3 seats/2 relax/ 2 arms chest puffs	786	799	816	848	874	912
Sofá 188 cm. 2 plazas/2 relax/2 brazos arcón puff 188 cm. 2 seats/2 relax/ 2 arms chest puff	775	785	800	832	858	896

MÓDULOS INDIVIDUALES / INDIVIDUAL UNITS	Denisse collection 1	Urban coleccion 2	Grupo 3 Group 3	Grupo 4 Group 4	Grupo 5 Group 5	Grupo 6 Group 6
Módulo Chaise 108 x170 cm. / 108 x 170 cm. Chaise module	297	305	325	344	355	379
Módulo Chaise 92 x170 cm. / 92 x 170 cm. Chaise module	290	299	316	335	346	370
Módulo 1 plaza 1 brazo 110 cm. relax/brazo arcón puff 110 cm. Module 1 seat 1 arm / relax arm chest puff	393	399	408	424	437	456
Módulo 1 plaza 1 brazo 94 cm. relax/brazo arcón puff 94 cm. Module 1 seat 1 arm / relax arm chest puff	387	392	400	416	429	448
Módulo 1 plaza sin brazo 78 cm. relax / 78 cm. Module 1 seat without arm relax	326	344	357	371	380	400
Módulo 1 plaza sin brazo 62 cm. relax / 62 cm. Module 1 seat without arm relax	318	332	348	362	371	391

Opcional sin coste: Brazo corto 24 cm.
Free Optional: Short arm 24 cm.

VALORACIÓN PUNTOS NETOS.
VALUATION NET POINTS.



La mano de las composiciones siempre será vista de frente.
The direction of the compositions always be facing forward.

Este modelo lleva de serie 2 relax eléctricos + arcón chaisse-longue + brazo corto con brazo siesta reclinable arcón y puff + 2 cojines de decoración. Cuando se quiera sin motor descontar 59 puntos. Cuando se quiera sin arcón en modulo chaisse-longue descontar 60 puntos..

This model comes standard with 2 electric relax + chaise longue chest + short arm reclining nap arm with chest and puff + 2 decorative cushions. When you want without motor, deduct 59 points. When you want without a chest in chaisse-longue module, deduct 60 points.

MEDIDAS / MEASUREMENTS

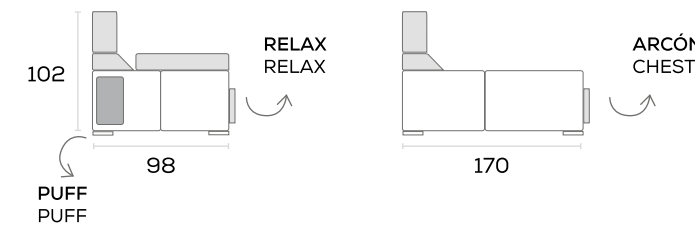

COMPOSICIONES / COMPOSITIONS

Comp. Chaise 300 x 170 cm. brazo puff arcón 300 x 170 cm. Chaise composition arm puff chest

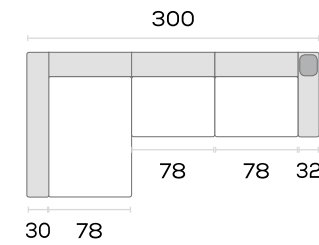

Sofá Maxi 300 cm. motorizado o fijo 298 cm. Maxi sofa motorized or fixed

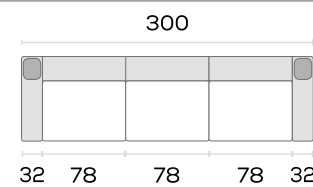

Comp. Chaise 250 x170 cm. brazo puff arcón 250 x 170 cm. Chaise Composition arm puff chest

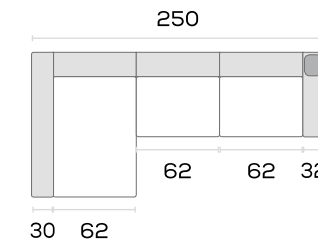

Sofá Maxi 250 cm. motorizado o fijo 250 cm. Maxi sofa motorized or fixed

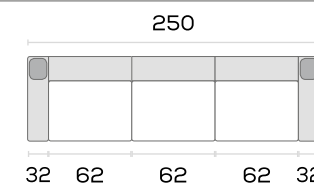

Módulo Chaise 108 x170 cm. 108 x 170 cm. Chaise module



Sofá 220 cm. motorizado o fijo 220 cm. Sofa motorized or fixed

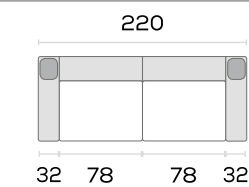

Módulo Chaise 92 x170 cm. 92 x 170 cm. Chaise module

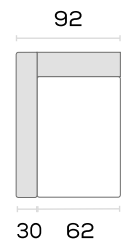

Sofá 188 cm. motorizado o fijo 188 cm. Sofa motorized or fixed

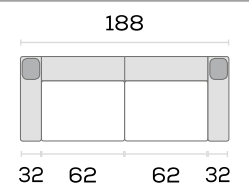

MÓDULOS / UNITS

Módulo 1 plaza 1 brazo 110 cm. 110 cm. Module 1 seat 1 arm

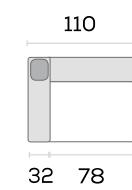

Módulo 1 plaza 1 brazo 94 cm. 94 cm. Module 1 seat 1 arm

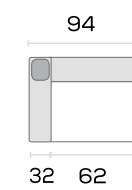

Módulo 1 plaza 78 cm. 78 cm. Module 1 seat

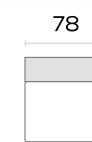

Módulo 1 plaza 62 cm. 62 cm. Module 1 seat

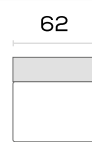

Medidas en centímetros (+/- 5 cm.)

Measurements in centimetres (+/- 5 cm.)



MOD.
CLOUD



CARACTERÍSTICAS / CHARACTERISTICS



MOD.
CLOUD

TABLA DE PUNTOS / TABLE OF POINTS



MEDIDAS / MEASUREMENTS

ESTRUCTURA / Structure

Madera de pino macizo 25 mm. / Tablero DM cubierta de poliuretano en diferentes grosores y densidades.

Solid pine 25 mm. / MDF cover of foam rubber in different thickness and densities.

SUSPENSIÓN / Suspension

Deslizante muelles + cincha NEA.

Sliding springs + elastic strap.

RESPALDO / Back

Espuma de poliuretano súper suave recubierta de fibra acrílica.

Foam rubber super soft acrylic fibre cover.

DESENFUNDABLE / Removable loose covers

Cabezas, riñoneras y asientos.

Heads, backs and seats.

ASIENTO DESLIZANTE / Sliding seat

Espuma de poliuretano 35 kg/m³.

Foam rubber 35 kg/m³.

RECUBRIMIENTO ESTRUCTURA / Structure coating

Espuma de poliuretano 20 kg/m³.

Foam rubber 20 kg/m³.

MECANISMO / Mechanism

Cabecal italiano reclinable microposición (respaldos), asientos deslizantes con rodamientos de nylon.

Italian reclinable head microposition (backs), sliding seats with nylon bearings.

PIE / Leg

(13 cm.) grafito. / (13 cm.) graphite.

Denisse collection 1	Urban collection 2	Grupo 3 Group 3	Grupo 4 Group 4	Grupo 5 Group 5	Grupo 6 Group 6
----------------------	--------------------	-----------------	-----------------	-----------------	-----------------

COMPOSICIONES / COMPOSITIONS						
Comp. Chaise 281 x 170 cm. / 281 x 170 cm. Chaise composition	670	696	729	752	789	847
Comp Chaise 251 x 170 cm. / 251 x 170 cm. Composition chaise	670	696	712	737	772	830
Sofá Maxi 281 cm. / 281 cm. maxi sofa	670	696	729	752	789	847
Sofá Maxi 251 cm. / 251 cm. maxi sofa	670	696	712	737	772	830
Sofá 204 cm./ 204 cm. sofa	435	460	479	499	550	573
Sofá 184 cm./ 184 cm. sofa	417	441	460	480	531	555

MÓDULOS INDIVIDUALES / INDIVIDUAL UNITS						
Módulo 1 plaza sin brazo 77 cm. / 77 cm. Module 1 seat without arm	268	278	289	297	311	330
Módulo 1 plaza sin brazo 67 cm. / 67 cm. Module 1 seat without arm	268	278	289	297	311	330

VALORACIÓN PUNTOS NETOS.
VALUATION NET POINTS.

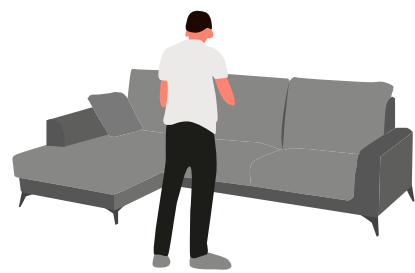

La mano de las composiciones siempre será vista de frente.
The direction of the compositions always be facing forward.



Opcional pie madera natural 12 cm. (sin coste).
12 cm. leg natural wood optional (without cost)



COMPOSICIONES / COMPOSITIONS

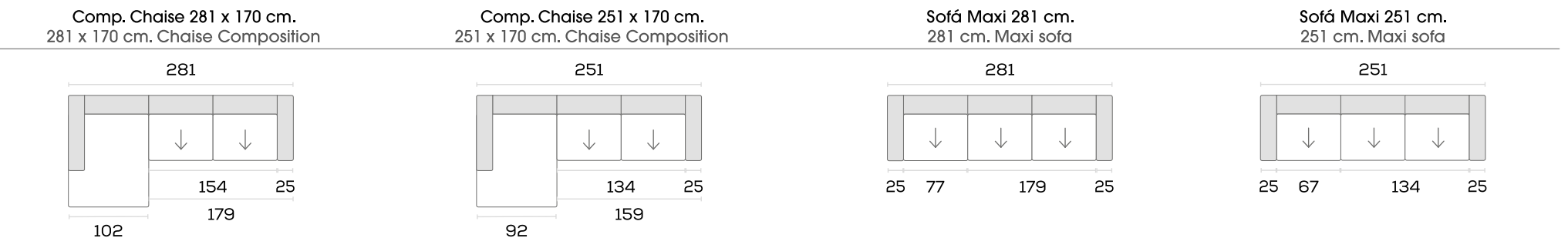

MÓDULOS / UNITS

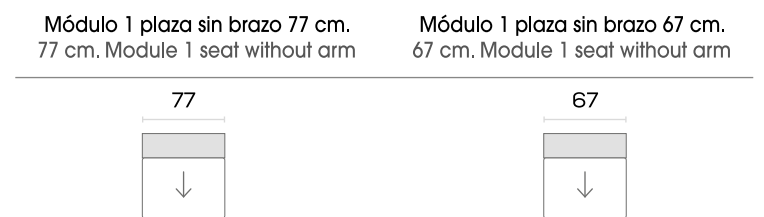

Medidas en centímetros (+/- 5 cm.)

Measurements in centimeters (+/- 5 cm.)



MOD.
KAZAN







ESTRUCTURA / Structure

Madera de pino Macizo 25 mm./ Tablero particulas DM

Solid pine 25 mm. / MDF.

SUSPENSIÓN / Suspension

Bastidor de muelle zig-zag.

Zig-zag spring frame.

RESPALDOS Y BRAZOS / Backs and arms

Fibra de poliéster ahuecada y siliconada antialérgica de alta recuperación.

Hollow siliconised polyester fibre, hypoallergenic and high recovery.

ASIENTO / Seat

Espuma de poliuretano 35 kg/m³ + 5 cm. supersoft recubierta de fibra acrílica.

Foam rubber 35 kg/m³ + 5 cm. super soft acrylic fibre cover.

DESENFUNDABLE / Removable loose covers

Asientos, brazos y respaldos / Asiento chaisnelongue NO desenfundable.

Seats, arms and backs. Chaise longue seat without removable covers.

RECUBRIMIENTO ESTRUCTURA / Structure coating

Espuma de poliuretano de 20 kg/m³ recubierta de fibra acrílica.

Foam rubber 20 kg/m³. Acrylic fibre cover.

MECANISMO / Mechanism

Relax motorizado.

Motorised relax.

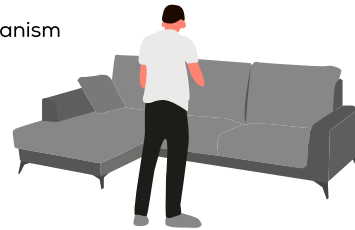

La mano de las composiciones siempre será vista de frente. The direction of the compositions always be facing forward.

TABLA DE PUNTOS / TABLE OF POINTS

Denisse collection 1	Urban collection 2	Grupo 3	Grupo 4	Grupo 5	Grupo 6
----------------------	--------------------	---------	---------	---------	---------

COMPOSICIONES CON MOTOR / COMPOSITIONS WITH MOTOR						
Comp. Chaise 300 x 170 cm. / 300 x 170 cm. chaise composition	986	1018	1060	1109	1142	1205
Comp. Chaise 250x170 cm. / 250x170 cm. chaise composition	986	1018	1036	1085	1118	1181
Sofá Maxi 300 cm. / 300 cm. maxi sofa	1020	1050	1078	1124	1159	1217
Sofá Maxi 250 cm. / 250 cm. maxi sofa	992	1023	1055	1101	1136	1194
Sofá 220 cm. 2 relax / 220 cm. Sofa 2 relax	688	712	734	766	792	830
Sofá 190 cm. 2 relax / 190 cm. Sofa 2 relax	672	696	718	750	776	814

MÓDULOS INDIVIDUALES / INDIVIDUAL UNITS						
Módulo chaise 100 cm./ 100 cm. chaise unit	-	-	349	368	379	403
Módulo chaise 94 cm./ 94 cm. chaise unit	-	-	340	359	370	394
Módulo 1 plaza 1 brazo 110 cm. motor / 110 cm. unit 1 seater motorised with arm	-	-	367	383	396	415
Módulo 1 plaza 1 brazo 94 cm. motor / 94 cm. unit 1 seater motorised with arm	-	-	359	375	388	407
Módulo 1 plaza sin brazo 78 cm. motor / 78 cm. unit 1 seater motorised without arm	-	-	344	358	367	387
Módulo 1 plaza sin brazo 62 cm. motor / 62 cm. unit 1 seater motorised without arm	-	-	337	351	360	380

Opcional sin coste: Brazo corto 24 cm.

Free Optional: Short arm 24 cm.

VALORACIÓN PUNTOS NETOS.

VALUATION NET POINTS.

Los brazos arcón no se fabrican en medida especial.

The chest in armrest are not manufactured in special measure.

La mano de las composiciones siempre será vista de frente.

The direction of the compositions always be facing forward.

Este modelo lleva de serie 2 relax eléctricos + arcón chaisnelongue + 2 brazos arcón chaisnelongue + 2 cojines decoración con rulo. Cuando se quiera sin motor descontar 59 puntos/unit. Cuando se quiera sin arcón en módulo chaisnelongue descontar 60 puntos.

This model has two electric relax + storage in the chaisnelongue unit + two chests in armrest + two decoration with roller cushions as standard. Subtract 59 points/units. If motor is not required. Subtract 60 points if chest is not required.

MEDIDAS / MEASUREMENTS

COMPOSICIONES / COMPOSITIONS

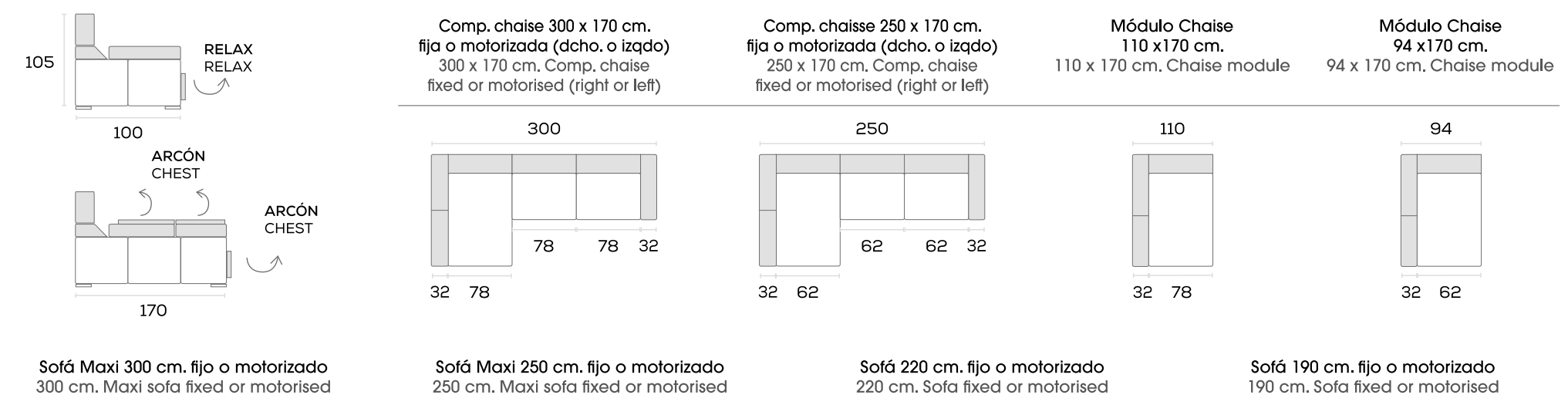

MÓDULOS / UNITS

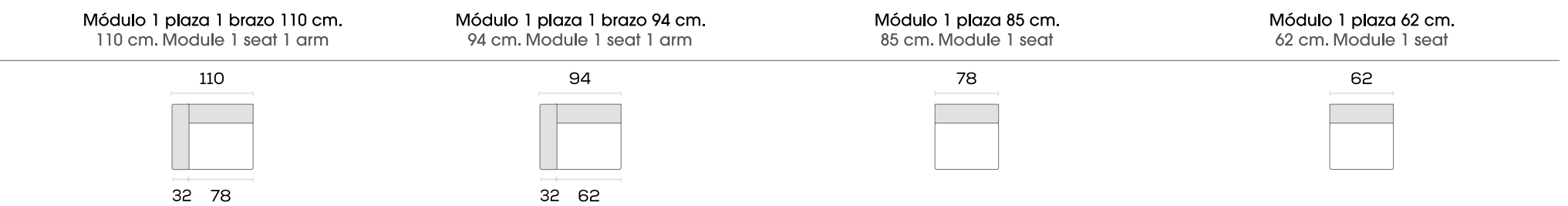

Medidas en centímetros (+/- 5 cm.)

Measurements in centimetres (+/- 5 cm.)



MOD.
KYOTO



CARACTERÍSTICAS / CHARACTERISTICS



MOD.
KYOTO

TABLA DE PUNTOS / TABLE OF POINTS



MEDIDAS / MEASUREMENTS

ESTRUCTURA / Structure

Madera de pino macizo 25 mm. / Tablero partículas DM.
Solid pine 25 mm. / MDF

SUSPENSIÓN / Suspension

Bastidor de muelles zig-zag. Cincha elástica.
Zig-zag spring frame. Elastic strap.

RESPALDOS Y BRAZOS / Backs and arms

Espuma de poliuretano súper suave recubierta de fibra acrílica.
Foam rubber super soft acrylic fibre cover.

ASIENTO DESLIZANTE A SUELO / Sliding seat to floor

Espuma de poliuretano 35 kg/m³.
Foam rubber 35 kg/m³.

DESENFUNDABLE / Removable loose covers

Asientos, brazos y respaldos.
Seats, arms and backs.
* Asiento chaisse-longue NO desenfundable.
* Chaisse-longue seat NOT removable

MECANISMO / Mechanism

Cabezal Italiano reclinable microposición (respaldo). Asiento apertura extraíble para cama.
Italian reclining head microposition (backs). Removable seats for bed.

RECUBRIMIENTO ESTRUCTURA / Structure coating

Espuma de poliuretano 20 kg/m³.
Foam rubber 20 kg/m³.

Denisse collection 1	Urban collection 2	Grupo 3 Group 3	Grupo 4 Group 4	Grupo 5 Group 5	Grupo 6 Group 6
----------------------	--------------------	-----------------	-----------------	-----------------	-----------------

COMPOSICIONES / COMPOSITIONS						
Comp. Chaise 292 x 150 cm. / 290x150 cm. chaise composition	764	799	834	858	865	928
Comp. Chaise 248x150 cm. / 248 x 150 cm. chaise composition	764	799	817	840	847	911
Sofá Maxi 292 cm. 3 asientos deslizantes / 292 cm. maxi sofa 3 sliding seats	729	765	799	824	829	895
Sofá Maxi 248 cm. 3 asientos deslizantes / 248 cm. sofa maxi 3 sliding seats	729	765	782	807	812	878
Sofá 3 plazas 215 cm. / 215 cm. 3 seaters sofa	398	414	435	448	463	473
Sofá 2 plazas 185 cm. / 185 cm. 2 seaters sofa	377	404	419	425	438	462

MÓDULOS INDIVIDUALES / INDIVIDUAL UNITS						
Módulo 1 plaza sin brazo 77 cm. / 77 cm. Module 1 seat without arm	331	351	364	379	387	422
Módulo 1 plaza sin brazo 62 cm. / 62 cm. Module 1 seat without arm	331	351	360	371	380	415

Opcional brazo sofá arcón / unidad: 65 puntos.
Arm sofa storage optional / 65 points unit.

VALORACIÓN PUNTOS NETOS.
VALUATION NET POINTS.

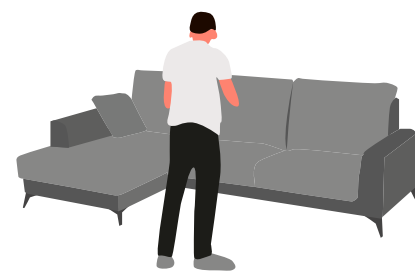

La mano de las composiciones siempre será vista de frente.
The direction of the compositions always be facing forward.

Este modelo de serie es deslizante, reclinable y arcón módulo chaisse-longue.
This model has sliding, reclining and storage in the chaise longue unit as standard.



COMPOSICIONES / COMPOSITIONS

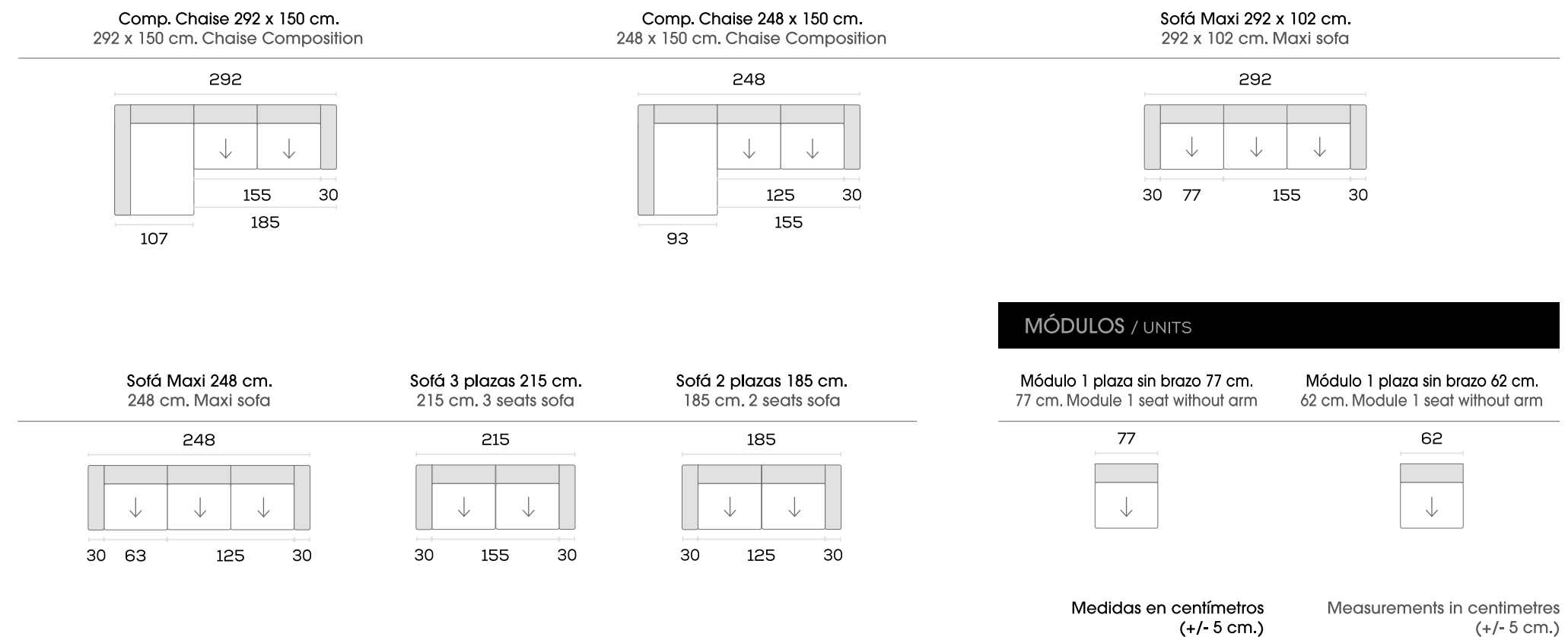



MOD.
LUCCA





CARACTERÍSTICAS / CHARACTERISTICS



TABLA DE PUNTOS / TABLE OF POINTS



COMPOSICIONES / COMPOSITIONS

ESTRUCTURA / Structure

Madera de pino macizo 25 mm. / Tablero partículas DM cubierta de espuma de poliuretano en diferentes grosores y densidades.

Solid pine 25 mm. / MDF particle board covered with polyurethane foam in different thicknesses and densities.

SUSPENSIÓN / Suspension

Deslizante muelles + cincha elástica.

Sliding springs + elastic strap.

RESPALDO / Back

Espuma de poliuretano súper suave recubierta de fibra acrílica.

Foam rubber super soft acrylic fibre cover.

ASIENTO / Seat

Espuma de poliuretano italiana 35 kg/m³.

Italian foam rubber 35 kg/m³.

DESENFUNDABLE / Removable loose covers

Asientos, respaldos y riñoneras.

Seats and backrests.

RECUBRIMIENTO ESTRUCTURA / Structure coating

Espuma de poliuretano de 20 kg/m³.

Foam rubber 20 kg/m³.

MECANISMO / Mechanism

Cabezal reclinable con bisagra microposición cromada, asientos deslizantes con rueda de nylon.

Reclining head hinged chromed microposition, sliding seats with nylon bearings.

PIE / Leg

12 cm. metálico cromo. / 12 cm. metallic chrome.

La mano de las composiciones siempre será vista de frente. The direction of the compositions always be facing forward.

Denisse collection 1	Urban collection 2	Grupo 3 Group 3	Grupo 4 Group 4	Grupo 5 Group 5	Grupo 6 Group 6
----------------------	--------------------	-----------------	-----------------	-----------------	-----------------

COMPOSICIONES / COMPOSITIONS.						
Comp. Terminal 297 x 200 cm. (Brazo 32 cm.) / 297 x 200 cm. terminal composition (Arm 32 cm.)	911	940	999	1027	1054	1117
Comp. Terminal 267 x 200 cm. (Brazo 32 cm.) / 267x200 cm. terminal composition (Arm 32 cm.)	911	940	999	1027	1054	1117
Comp. Chaise 292 x 170 cm. (Brazo 32 cm.) / 292x170 cm. chaise composition (Arm 32 cm.)	841	869	927	955	984	1047
Comp. Chaise 247 x 170 cm. (Brazo 32 cm.) / 247x170 cm. chaise composition (Arm 32 cm.)	841	869	927	955	984	1047
Sofá 254 cm. (2 módulos) (Brazo 32 cm.) / 254 cm. sofa. (2 unit) (Arm 32 cm.)	580	606	625	645	663	685
Sofá 230 cm. (2 módulos) (Brazo 20 cm.) / 230 cm. sofa. (2 unit) (Arm 20 cm.)	580	606	625	645	663	685
Sofá 219 cm. (Brazo 32 cm.) / 219 cm. sofa. (Arm 32 cm.)	492	518	538	555	575	594
Sofá 195 cm. (Brazo 20 cm.) / 195 cm. sofa. (Arm 20 cm.)	492	518	538	555	575	594
Sofá 189 cm. (Brazo 32 cm.) / 189 cm. sofa. (Arm 32 cm.)	475	498	523	539	558	565
Sofá 165 cm. (Brazo 20 cm.) / 165 cm. sofa. (Arm 20 cm.)	475	498	523	539	558	565

MÓDULOS INDIVIDUALES / INDIVIDUAL UNITS						
Módulo 1 plaza sin brazo 77 cm. / 77 cm. Module 1 seat without arm	-	-	318	329	353	370
Módulo 1 plaza sin brazo 62 cm. / 62 cm. Module 1 seat without arm	-	-	318	329	353	370

Opcional: Brazo corto 20 cm. Incremento 45 puntos chaiselongue y rincón terminal. VALORACIÓN PUNTOS NETOS.
Optional: 20 cm. short arm sofa. Increase 45 points chaiselongue and corner. VALUATION NET POINTS.



La mano de las composiciones siempre será vista de frente. The direction of the compositions always be facing forward.



Opcional pie madera natural 12 cm. (sin coste). 12 cm. leg natural wood optional (without cost)

MEDIDAS / MEASUREMENTS

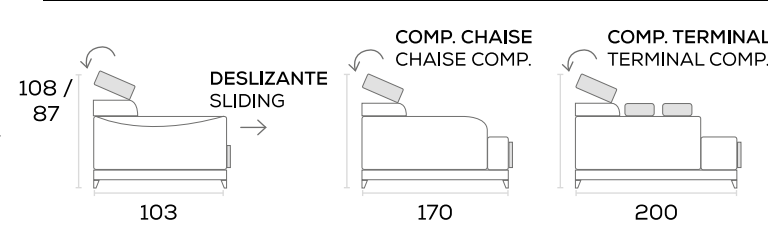

Comp. Terminal 297 x 200 cm. 297 x 200 cm. Terminal Composition	Comp. Terminal 267 x 200 cm. 67 x 200 cm. Terminal Composition	Comp. Chaise 292 x 170 cm. 292 x 170 cm. Chaise Composition	Comp. Chaise 252 x 170 cm. 252 x 170 cm. Chaise Composition
---	--	---	---

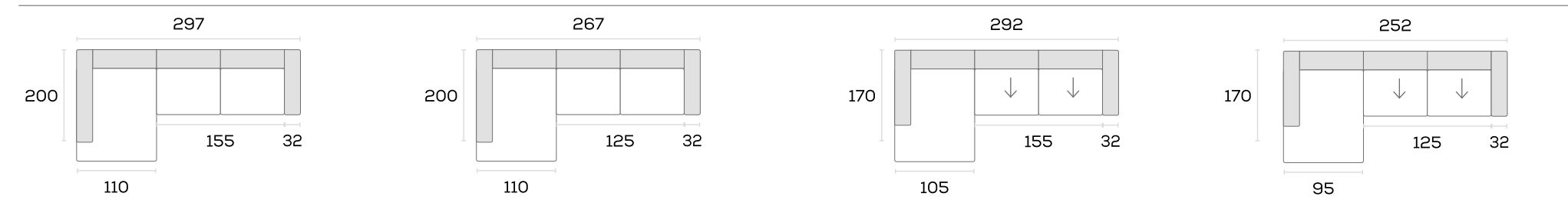

Sofá 254 cm. 254 cm. Sofa	Sofá 230 cm. 230 cm. Sofa	Sofá 219 cm. 219 cm. Sofa	Sofá 195 cm. 195 cm. sofa
---------------------------	---------------------------	---------------------------	---------------------------



Sofá 189 cm. 189 cm. sofa	Sofá 165 cm. 165 cm. sofa
---------------------------	---------------------------

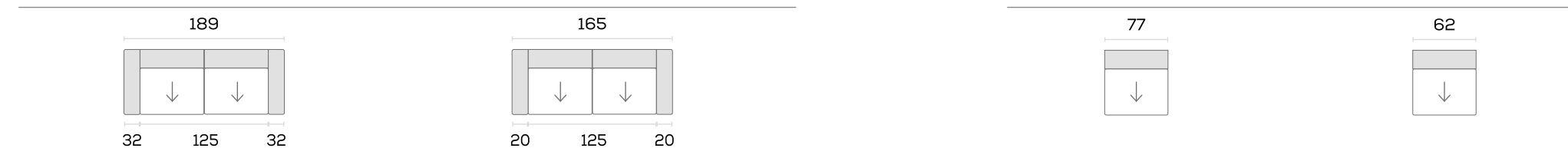

MÓDULOS / UNITS

Módulo 1 plaza sin brazo 77 cm. 77 cm. Module 1 seat without arm	Módulo 1 plaza sin brazo 62 cm. 62 cm. Module 1 seat without arm
--	--



Medidas en centímetros (+/- 5 cm.) Measurements in centimeters (+/- 5 cm.)



MOD.
MISTRÁ

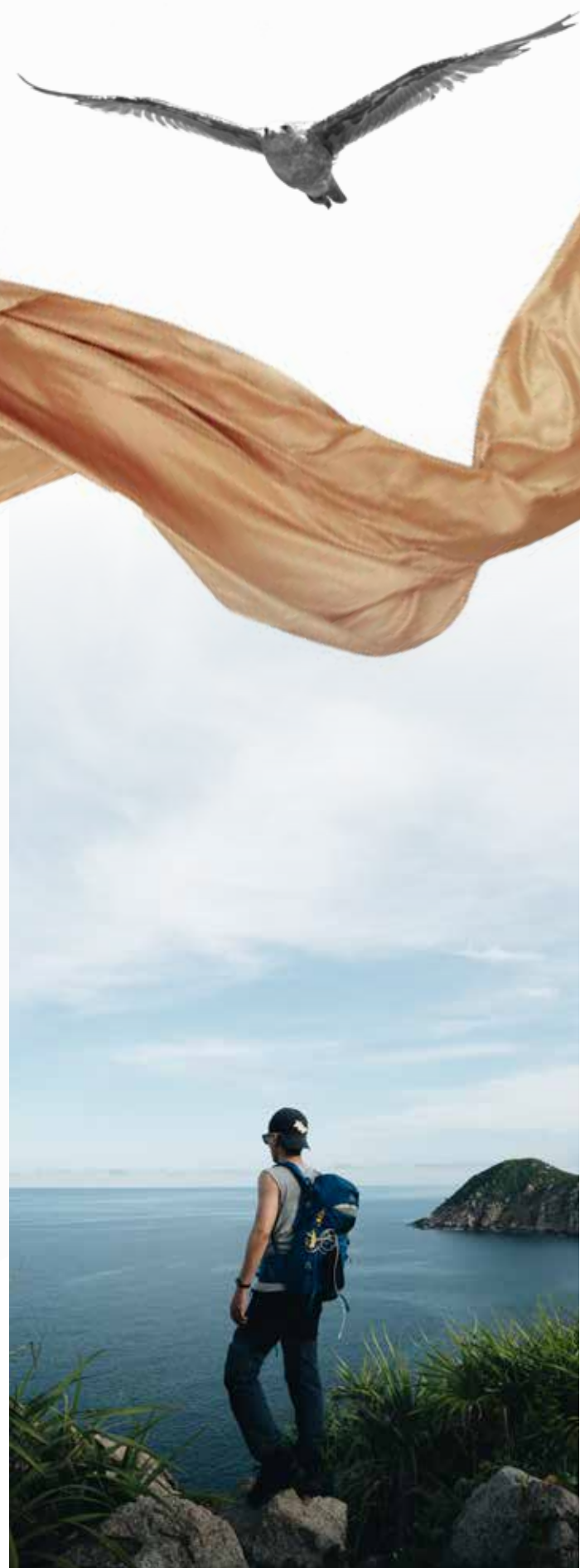



CARACTERÍSTICAS / CHARACTERISTICS



MOD.
MISTRÁ

TABLA DE PUNTOS / TABLE OF POINTS



MEDIDAS / MEASUREMENTS

ESTRUCTURA / Structure

Madera de pino macizo 25 mm. / Tablero partículas DM cubierta de espuma de poliuretano en diferentes grosores y densidades.

Solid pine 25 mm. / MDF particle board covered with polyurethane foam in different thicknesses and densities.

SUSPENSIÓN / Suspension

Deslizante muelles + cincha NEA.

Sliding springs + elastic strap.

RESPALDOS / Backs

Espuma de poliuretano súper suave recubierta de fibra acrílica.

Foam rubber super soft acrylic fibre cover.

DESENFUNDABLE / Removable loose covers

Brazos, asientos, respaldos y riñoneras.

Arms, seats, backs and kidneys.

ASIENTO DESLIZANTE / Sliding seat

Espuma de poliuretano 35 kg/m³.

Foam rubber 35 kg/m³.

RECUBRIMIENTO ESTRUCTURA / Structure coating

Espuma de poliuretano 20 kg/m³.

Foam rubber 20 kg/m³.

MECANISMO / Mechanism

Cabezal italiano reclinable microposición (respaldos), asientos deslizantes con rodamientos de nylon.

Italian reclining head microposition (backs), sliding seats with nylon bearings.

PIE / Leg

Grafito y cromo (13 cm.)

/(13 cm.) Graphite and chrome.

Esta chaiselongue de serie lleva brazo arcón en módulo chaise.

This standard chaise longue has a chest arm in a chaise module.

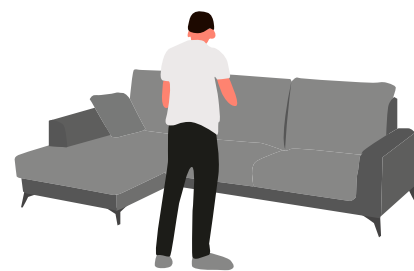

La mano de las composiciones siempre será vista de frente.
The direction of the compositions always be facing forward.



Opcional pie madera natural 12 cm. (sin coste).
12 cm. leg natural wood optional (without cost)

Denisse collection 1	Urban collection 2	Grupo 3 Group 3	Grupo 4 Group 4	Grupo 5 Group 5	Grupo 6 Group 6
----------------------	--------------------	-----------------	-----------------	-----------------	-----------------

COMPOSICIONES / COMPOSITIONS	Denisse collection 1	Urban collection 2	Grupo 3 Group 3	Grupo 4 Group 4	Grupo 5 Group 5	Grupo 6 Group 6
Comp. Chaise 280 x 170 cm. / 280 x 170 cm. chaise composition	715	724	747	797	834	892
Comp. Chaise 250 x 170 cm. / 250 x 170 cm. chaise composition	705	726	737	782	817	875
Sofá Maxi 273 cm. 3 asientos deslizantes / 273 cm. maxi sofa 3 sliding seats	715	724	747	797	834	892
Sofá Maxi 237 cm. 3 asientos deslizantes / 237 cm. maxi sofa 3 sliding seats	705	726	737	782	817	875
Sofá 238 cm. 2 módulos / Sofa 238 cm. 2 modules	530	555	574	594	645	668
Sofá 195 cm. / Sofa 195 cm.	464	479	498	518	569	592
Sofá 175 cm. / Sofa 175 cm.	424	448	467	507	538	562

MÓDULOS INDIVIDUALES / INDIVIDUAL UNITS	Denisse collection 1	Urban collection 2	Grupo 3 Group 3	Grupo 4 Group 4	Grupo 5 Group 5	Grupo 6 Group 6
Módulo 1 plaza sin brazo 77 cm. / 77 cm. Module 1 seat without arm	-	-	285	292	305	325
Módulo 1 plaza sin brazo 67 cm. / 67 cm. Module 1 seat without arm	-	-	285	292	305	325

VALORACIÓN PUNTOS NETOS.
VALUATION NET POINTS.

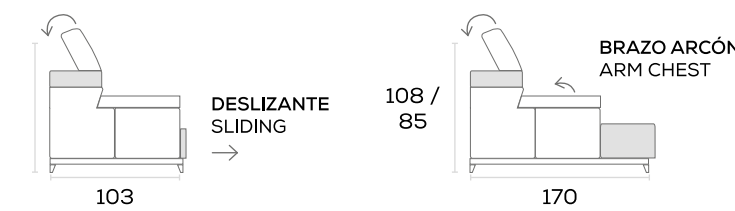

COMPOSICIONES / COMPOSITIONS

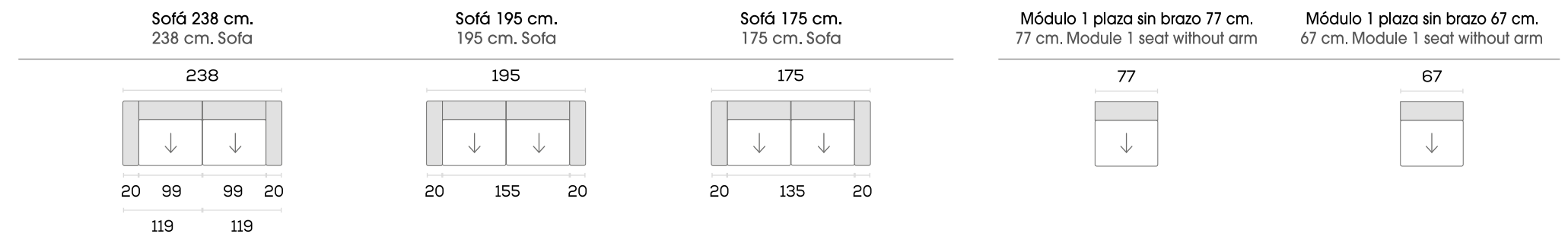
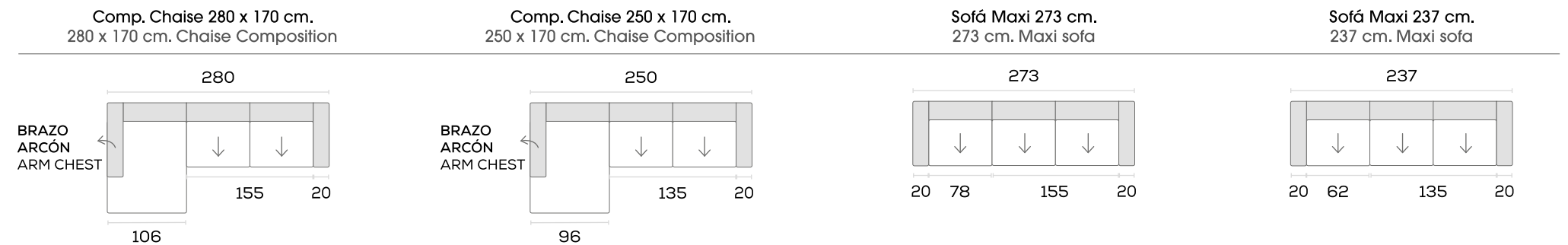

MÓDULOS / UNITS

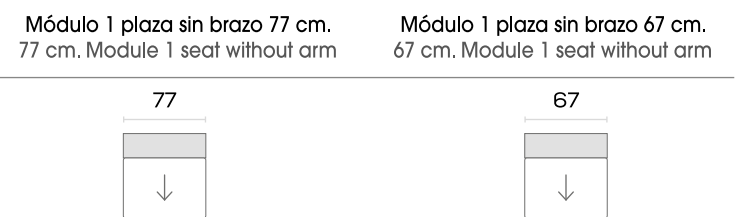

Medidas en centímetros (+/- 5 cm.)
Measurements in centimetres (+/- 5 cm.)



MOD.
NEOS



CARACTERÍSTICAS / CHARACTERISTICS

ESTRUCTURA / Structure

Madera de pino macizo 25 mm. / Tablero particulas DM cubierta de espuma de poliuretano en diferentes grosores y densidades.

Solid pine 25 mm. / MDF particle board covered with polyurethane foam in different thicknesses and densities.

SUSPENSIÓN / Suspension

Deslizante muelles + cincha NEA.

Sliding springs + elastic strap.

RESPALDOS / Backs

Espuma de poliuretano súper suave recubierta de fibra acrílica.

Foam rubber super soft acrylic fibre cover.

DESENFUNDABLE / Removable loose covers

Cabezas, riñoneras, asientos y brazos.

Heads, backs, seats and arms.

ASIENTO DESLIZANTE / Sliding seat

Espuma de poliuretano 35 kg/m³.

Foam rubber 35 kg/m³.

RECUBRIMIENTO ESTRUCTURA / Structure coating

Espuma de poliuretano 20 kg/m³.

Foam rubber 20 kg/m³.

MECANISMO / Mechanism

Cabezal Italiano reclinable microposición (respaldos), asientos deslizantes con rodamientos de nylon.

Italian reclining head microposition (backs), sliding seats with nylon bearings.

PIE / Leg

(13 cm.) grafito. / (13 cm.) graphite.



MOD.
NEOS

TABLA DE PUNTOS / TABLE OF POINTS

Denisse collection 1	Urban collection 2	Grupo 3 Group 3	Grupo 4 Group 4	Grupo 5 Group 5	Grupo 6 Group 6
----------------------	--------------------	-----------------	-----------------	-----------------	-----------------

COMPOSICIONES / COMPOSITIONS						
Rincón Terminal 292 x 200 cm. / 292 x 200 cm. Corner terminal	952	981	1040	1068	1095	1158
Rincón Terminal 272 x 200 cm. / 272 x 200 cm. Corner terminal	952	981	1040	1068	1095	1158
Comp. Chaise 287 x 170 cm. / 287 x 170 cm. chaise composition	641	667	700	723	760	818
Comp. Chaise 257 x 170 cm. / 257 x 170 cm. chaise composition	641	667	683	708	743	801
Sofá Maxi 287 cm. / 287 cm. maxi sofa	641	667	700	723	760	818
Sofá Maxi 257 cm. / 257 cm. maxi sofa	641	667	683	708	743	801
Sofá 254 cm. 2 módulos / 254 cm. s sofa 2 modules	555	580	599	619	670	693
Sofá 210 cm. / 210 cm. sofa	406	431	450	470	521	544
Sofá 190 cm. / 190 cm. sofa	388	412	431	451	502	526

MÓDULOS INDIVIDUALES / INDIVIDUAL UNITS						
Módulo 1 plaza sin brazo 77 cm. / 77 cm. Module 1 seat without arm	-	-	281	289	303	322
Módulo 1 plaza sin brazo 67 cm. / 67 cm. Module 1 seat without arm	-	-	281	289	303	322

VALORACIÓN PUNTOS NETOS.
VALUATION NET POINTS.



La mano de las composiciones siempre será vista de frente.
The direction of the compositions always be facing forward.



Opcional pie madera natural 12 cm. (sin coste).
12 cm. leg natural wood optional (without cost)



MEDIDAS / MEASUREMENTS

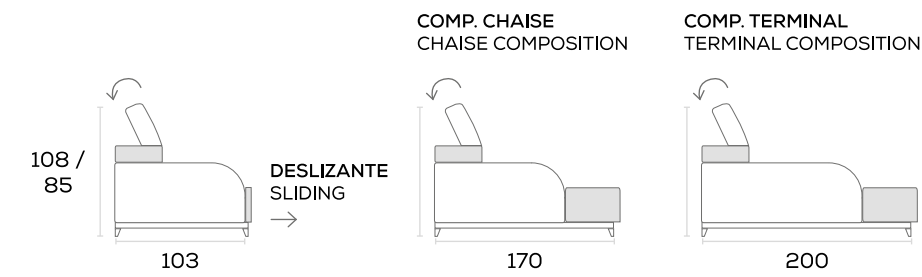

COMPOSICIONES / COMPOSITIONS

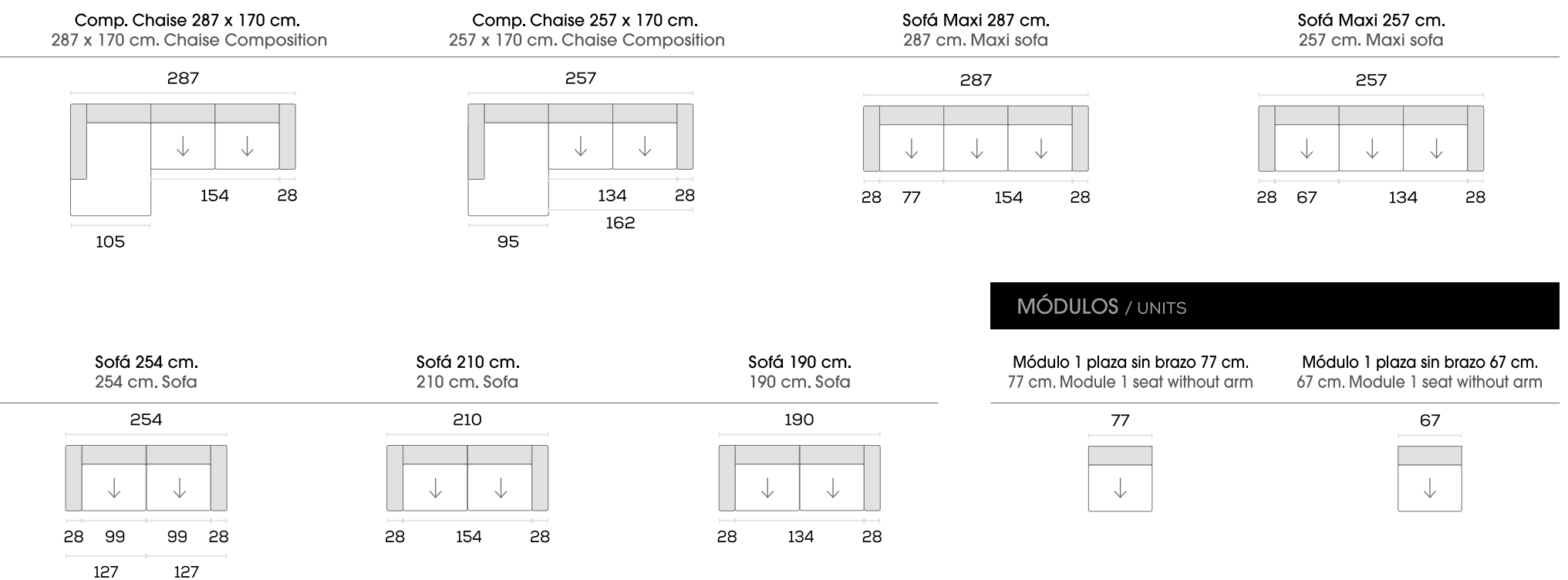

MÓDULOS / UNITS

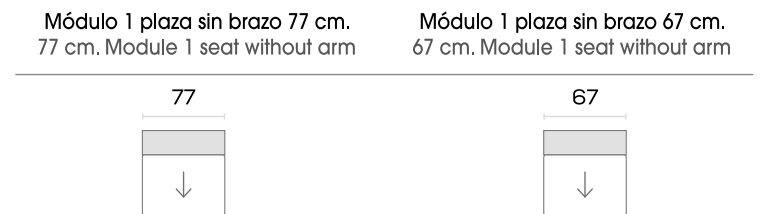

Medidas en centímetros (+/- 5 cm.)

Measurements in centimetres (+/- 5 cm.)



MOD.
PORTOFINO



MOD.
PORTOFINO



CARACTERÍSTICAS / CHARACTERISTICS

TABLA DE PUNTOS / TABLE OF POINTS

ESTRUCTURA / Structure

Madera de pino macizo 25 mm. / Tablero partículas DM cubierta de espuma de poliuretano en diferentes grosores y densidades.

Solid pine 25 mm. / MDF particle board covered with polyurethane foam in different thicknesses and densities.

SUSPENSIÓN / Suspension

Deslizante muelles + cincha NEA.

Sliding springs + elastic strap.

RESPALDOS / Backs

Espuma de poliuretano súper suave recubierta de fibra acrílica.

Foam rubber super soft acrylic fibre cover.

DESENFUNDABLE / Removable loose covers

Cabezas, riñoneras y asientos.

Heads, backs and seats.

ASIENTO DESLIZANTE / Sliding seat

Espuma de poliuretano 35 kg/m³.

Foam rubber 35 kg/m³.

RECUBRIMIENTO ESTRUCTURA / Structure coating

Espuma de poliuretano 20 kg/m³.

Foam rubber 20 kg/m³.

MECANISMO / Mechanism

Cabezal Italiano reclinable microposición (respaldos), asientos deslizantes con rodamientos de nylon.

Italian reclinable head microposition (backs), sliding seats with nylon bearings.

PIE / Leg

(13 cm.) grafito o plata. / (13 cm.) chrome or graphite.

COMPOSICIONES / COMPOSITIONS	Denisse collection 1	Urban collection 2	Grupo 3 Group 3	Grupo 4 Group 4	Grupo 5 Group 5	Grupo 6 Group 6
Comp. Chaise 285 x 170 cm. / 285 x 170 cm. chaise composition	673	699	732	755	792	850
Comp. Chaise 255 x 170 cm. / 255 x 170 cm. chaise composition	670	696	712	737	772	830
Sofá Maxi 277 cm. / 277 cm. maxi sofa	673	699	732	755	792	850
Sofá Maxi 241 cm. / 241 cm. maxi sofa	670	696	712	737	772	830
Sofá 242 cm. (2 módulos) / 242 cm. sofa 2 moduls	500	525	544	564	615	638
Sofá 199 cm. / 199 cm. sofa	424	449	468	488	539	562
Sofá 180 cm. / 180 cm. sofa	402	426	445	465	516	540

MÓDULOS INDIVIDUALES / INDIVIDUAL UNITS	Denisse collection 1	Urban collection 2	Grupo 3 Group 3	Grupo 4 Group 4	Grupo 5 Group 5	Grupo 6 Group 6
Módulo 1 plaza sin brazo 77 cm. / 77 cm. Module 1 seat without arm	-	-	290	297	312	340
Módulo 1 plaza sin brazo 67 cm. / 67 cm. Module 1 seat without arm	-	-	290	297	312	340

VALORACIÓN PUNTOS NETOS.
VALUATION NET POINTS.



La mano de las composiciones siempre será vista de frente.
The direction of the compositions always be facing forward.



Opcional pie madera natural 12 cm. (sin coste).
12 cm. leg natural wood optional (without cost)

MEDIDAS / MEASUREMENTS



COMPOSICIONES / COMPOSITIONS

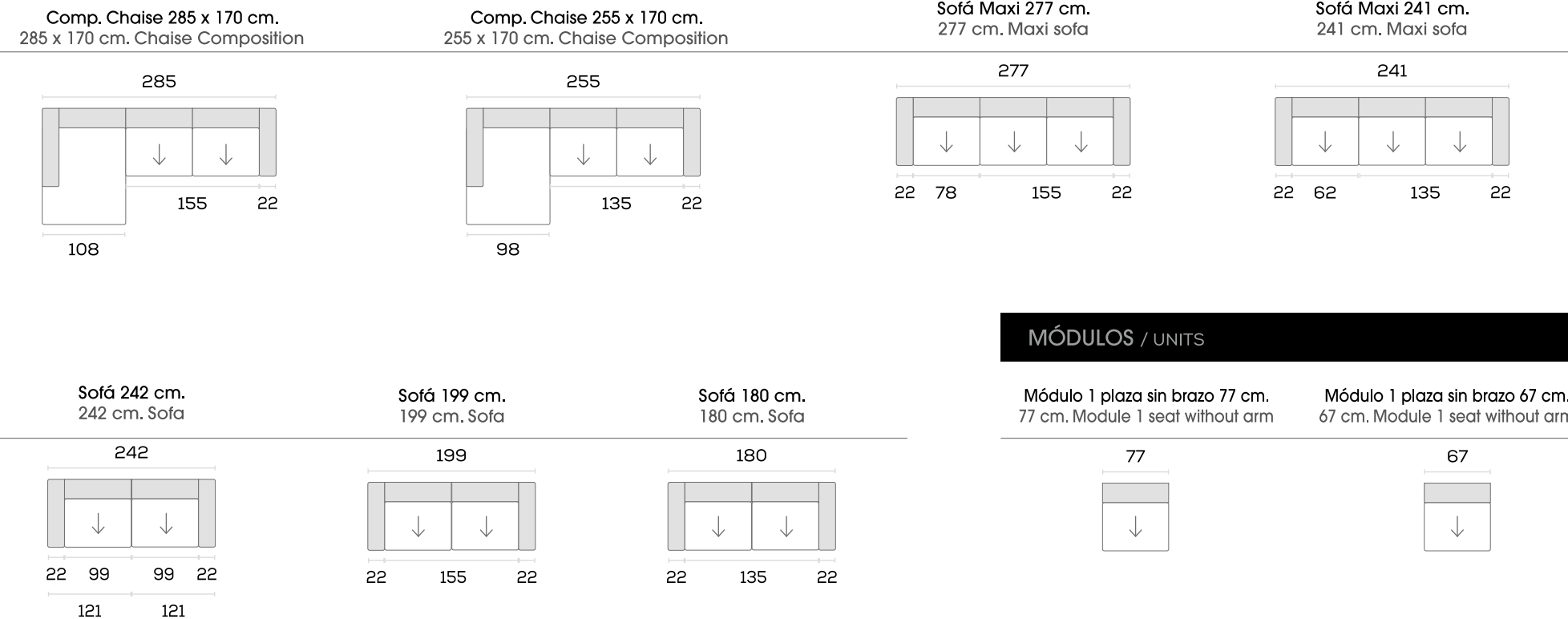

MÓDULOS / UNITS

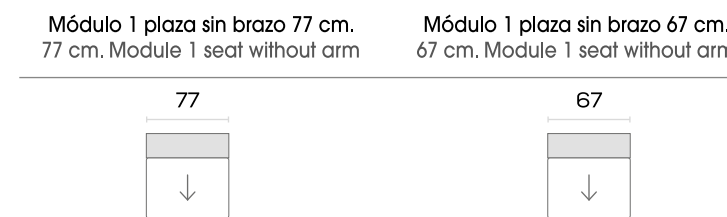

Medidas en centímetros (+/- 5 cm.)
Measurements in centimetres (+/- 5 cm.)

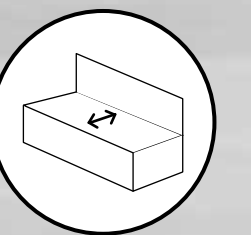

FONDO REDUCIDO
REDUCED DEPTH
83 cm

MOD.
ROMA





GABE
TAPIZADOS
Mucho más que confort

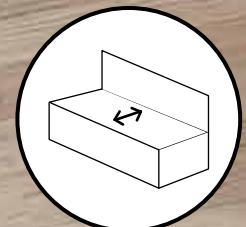

FONDO REDUCIDO
REDUCED DEPTH
83 cm





CARACTERÍSTICAS / CHARACTERISTICS



FONDO REDUCIDO
REDUCED DEPTH
83 cm

MOD.
ROMA

TABLA DE PUNTOS / TABLE OF POINTS

ESTRUCTURA / Structure

Madera de pino macizo 25 mm. / Tablero partículas DM
Solid pine 25 mm. / MDF particle board

SUSPENSIÓN / Suspension

Bastidor muelles + cincha NEA.
Spring frame + NEA webbing.

RESPALDO / Back

Fibra de poliéster ahuecada y siliconada antialérgicade alta recuperación.
Hollow siliconised polyester fibre, hypoallergenic and high recovery.

ASIENTO / Seat

Espuma de poliuretano de 35 kg/m³.
Foam rubber 35 kg/m³.

DESENFUNDABLE / Removable loose

Brazos, Asientos y respaldos.
Arms, seats and back.

MECANISMO / Mechanism

Cabezal reclinable y asientos deslizantes con rodamientos de nylon.
Reclining head sliding seats with nylon wheel.

RECUBRIMIENTO ESTRUCTURA / Structure coating

Espuma de poliuretano 20 kg/m³.
Foam rubber 20 kg/m³.

PIE / Leg

Cromado. Chrome plated

Este modelo de serie es deslizante, reclinable y arcón módulo chaiselongue.
This model has sliding, reclining and storage in the chaise longue unit as standard.

VALORACIÓN PUNTOS NETOS.
VALUATION NET POINTS.

Denisse collection 1	Urban coleccion 2	Grupo 3 Group 3	Grupo 4 Group 4	Grupo 5 Group 5	Grupo 6 Group 6
-------------------------	----------------------	--------------------	--------------------	--------------------	--------------------

COMPOSICIONES / COMPOSITIONS	Denisse collection 1	Urban coleccion 2	Grupo 3 Group 3	Grupo 4 Group 4	Grupo 5 Group 5	Grupo 6 Group 6
Comp. Chaise 340 x 160 cm. 4 asientos / 340 x 160 cm. Chaise Composition 4 seats	899	939	974	1005	1041	1095
Comp. Chaise 300 x 160 cm. 4 asientos / 300 x 160 cm. Chaise Composition 4 seats	877	917	949	977	1013	1064
Comp. Chaise 262 x 160 cm. 3 asientos / 262 x 160 cm. Chaise Composition 3 seats	704	739	768	793	823	875
Comp. Chaise 232 x 160 cm. 3 asientos / 232 x 160 cm. Chaise Composition 3 seats	682	717	746	770	799	852
Sofá Maxi 340 cm. 4 asientos deslizantes 2 módulos / 340 cm. sofa maxi. 4 sliding seats 2 modules	800	842	874	898	926	1012
Sofá Maxi 300 cm. 4 asientos deslizantes 2 módulos / 300 cm. sofa maxi. 4 sliding seats 2 modules	784	826	868	910	950	1006
Sofá Maxi 262 cm. 3 asientos deslizantes / 262 cm. sofa maxi. 3 sliding seats	620	650	670	686	706	756
Sofá Maxi 232 cm. 3 asientos deslizantes / 232 cm. sofa maxi. 3 sliding seats	609	639	664	688	715	748
Sofá 185 cm. asientos deslizantes / 185 cm. sofa sliding seats	406	431	450	470	521	544
Sofá 165 cm. asientos deslizantes / 165 cm. sofa sliding seats	388	412	431	451	502	526

MÓDULOS INDIVIDUALES / INDIVIDUAL UNITS	Denisse collection 1	Urban coleccion 2	Grupo 3 Group 3	Grupo 4 Group 4	Grupo 5 Group 5	Grupo 6 Group 6
Módulo chaise 92 cm. / 92 cm. chaise unit	304	318	331	344	360	369
Módulo chaise 82 cm. / 82 cm. chaise unit	290	304	312	315	324	349
Módulo 170 cm. asientos deslizantes 1 brazo / Mod. 170 cm. sliding seats 1 arm	400	421	437	449	463	506
Módulo 150 cm. asientos deslizantes 1 brazo / Mod. 150 cm. sliding seats 1 arm	392	413	430	440	455	499
Módulo 1 plaza 1 brazo 92 cm. / 92 cm. Module 1 seat 1 arm	220	229	233	237	243	250
Módulo 1 plaza 1 brazo 82 cm. / 82 cm. Module 1 seat 1 arm	217	226	230	233	240	245
Módulo 1 plaza sin brazo 77 cm. / 77 cm. Module 1 seat without arm	195	200	206	212	218	220
Módulo 1 plaza sin brazo 67 cm. / 67 cm. Module 1 seat without arm	195	200	203	207	214	212

MEDIDAS / MEASUREMENTS



La mano de las composiciones siempre será vista de frente.
The direction of the compositions always be facing forward.



COMPOSICIONES / COMPOSITIONS

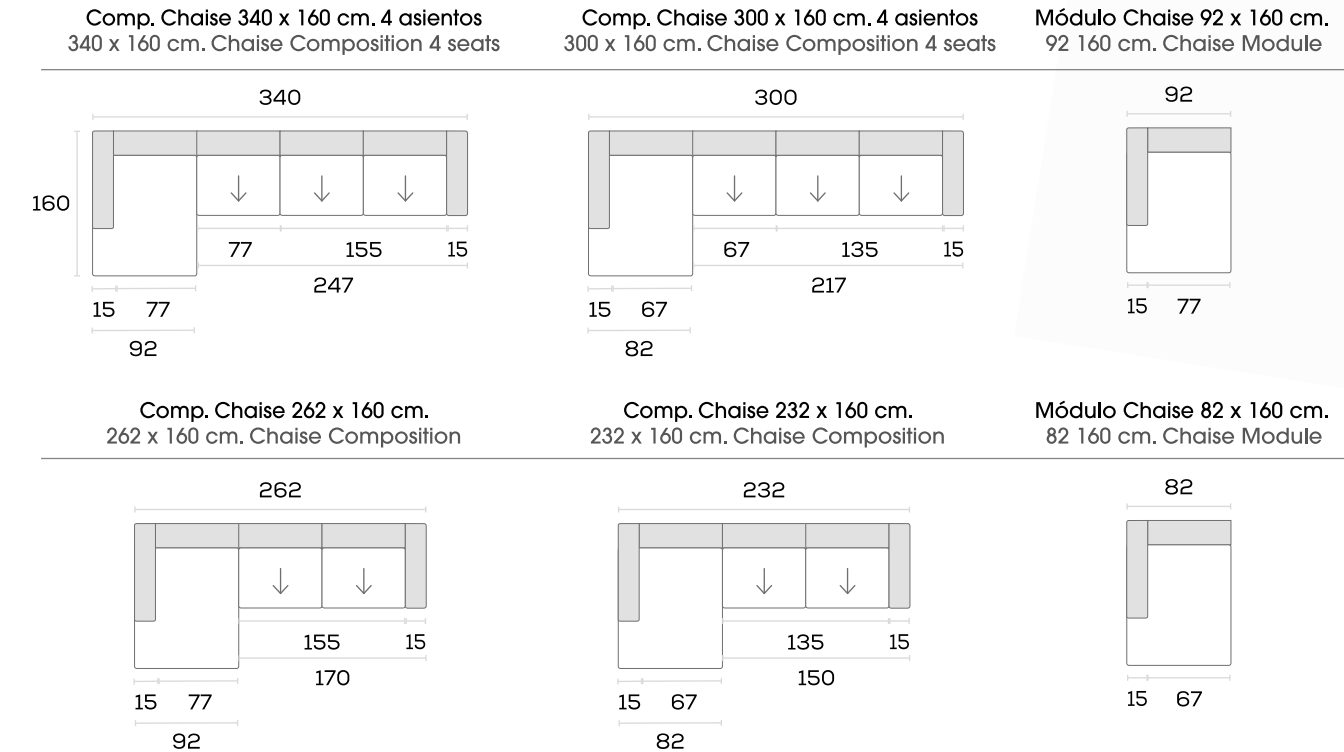

COMPOSICIONES / COMPOSITIONS

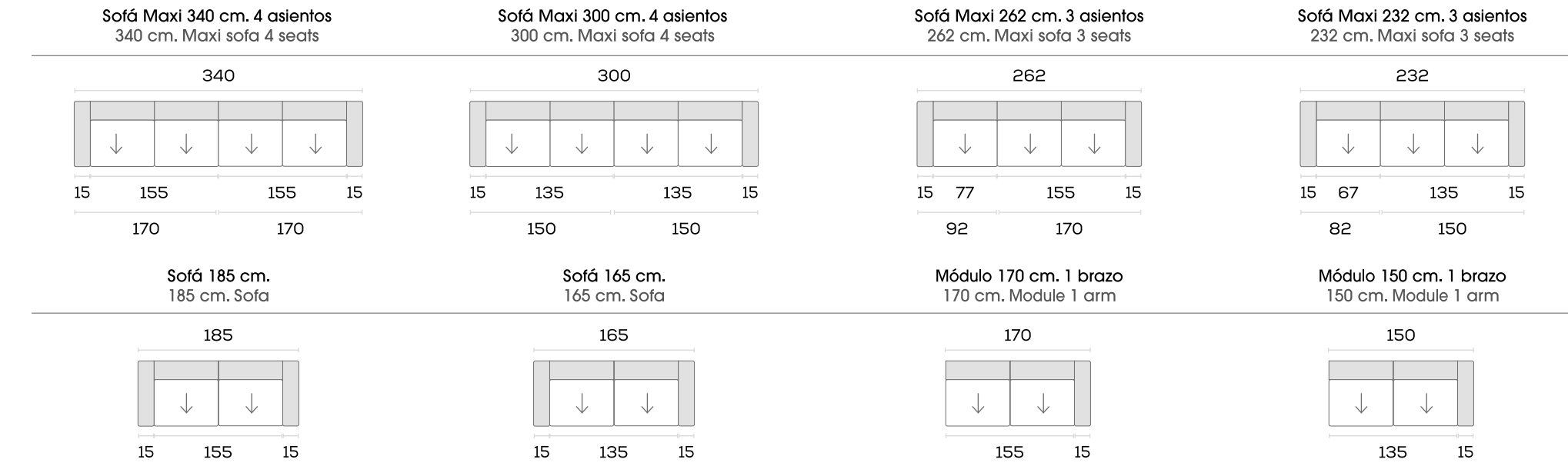

MÓDULOS / UNITS

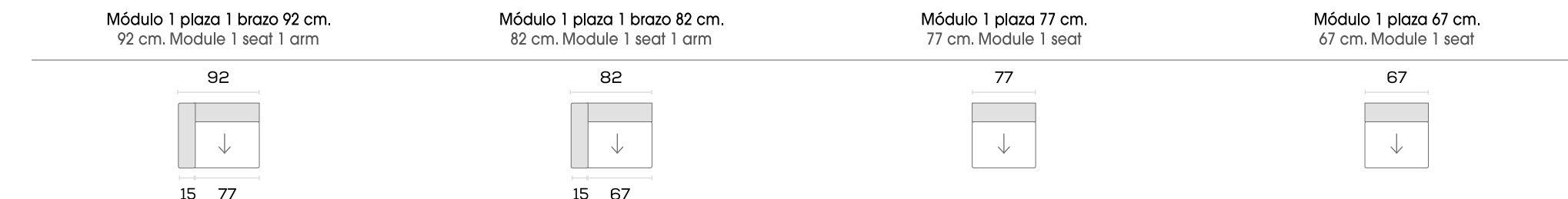

Medidas en centímetros (+/- 5 cm.)
Measurements in centimetres (+/- 5 cm.)

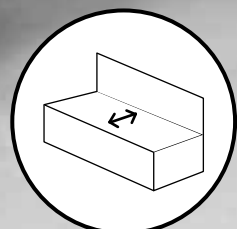

FONDO REDUCIDO
REDUCED DEPTH
85 cm

MOD.
SAMOA



CARACTERÍSTICAS / CHARACTERISTICS

TABLA DE PUNTOS / TABLE OF POINTS

MEDIDAS / MEASUREMENTS

ESTRUCTURA / Structure

Madera de pino macizo 25 mm. / Tablero DM.
Solid pine 25 mm. / MDF.

SUSPENSIÓN / Suspension

Bastidor de muelle zig-zag.
Zig-zag spring frame.

RESPALDOS Y BRAZOS / Backs and arms

Fibra de poliéster ahuecada y siliconada antialérgica de alta recuperación.
Hollow siliconised polyester fibre, hypoallergenic and high recovery.

ASIENTO / Seat

Espuma de poliuretano 35 kg/m³ recubierta de fibra acrílica.
Foam rubber 35 kg/m³ acrylic fibre cover.

DESENFUNDABLE / Removable loose

Asientos, brazos y respaldos desenfundables.
Seats, arms and backs.

MECANISMO / Mechanism

Relax motorizado.
Motorised relax.

RECUBRIMIENTO

ESTRUCTURA / Structure coating
Espuma de poliuretano 20 kg/m³ recubierta de fibra acrílica.
Foam rubber 20 kg/m³. Acrylic fibre cover.

PIE / Leg

Cromado. Chrome plated

Denisse collection 1	Urban collection 2	Grupo 3 Group 3	Grupo 4 Group 4	Grupo 5 Group 5	Grupo 6 Group 6
----------------------	--------------------	-----------------	-----------------	-----------------	-----------------

COMPOSICIONES / COMPOSITIONS						
Sofá Maxi 282 cm. 3 asientos relax / 282 cm. sofa maxi 3 relax seats	896	931	969	994	1039	1065
Sofá Maxi 234 cm. 3 asientos relax / 234 cm. sofa maxi 3 relax seats	896	931	956	981	1014	1041
Sofá 204 cm. 2 plazas 2 relax / 204 cm. 2 seaters sofa 2 relax	615	634	670	688	718	735
Sofá 172 cm. 2 plazas 2 relax / 172 cm. 2 seaters sofa 2 relax	615	634	664	676	706	722
Sofá Fijo 204 cm. (1 módulo) / 204 cm. Fixed Sofa (1 module)	411	438	462	475	505	539
Sofá Fijo 172 cm. (1 módulo) / 172 cm. Fixed Sofa (1 module)	399	424	440	465	472	515

MÓDULOS INDIVIDUALES / INDIVIDUAL UNITS						
Módulo 1 plaza sin brazo 78 cm. / 78 cm. Module 1 seat without arm	280	289	299	306	321	330
Módulo 1 plaza sin brazo 62 cm. / 62 cm. Module 1 seat without arm	280	289	292	305	308	319

VALORACIÓN PUNTOS NETOS.
VALUATION NET POINTS.

La mano de las composiciones siempre será vista de frente.
The direction of the compositions always be facing forward.

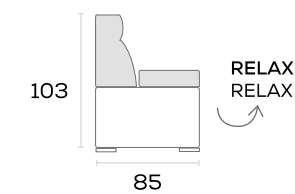

COMPOSICIONES / COMPOSITIONS

Sofá Maxi 282 cm. 3 asientos relax
282 cm. Maxi sofa 3 seats relax

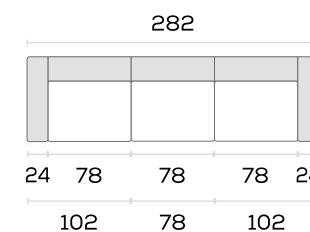

Sofá Maxi 234 cm. 3 asientos relax
234 cm. Maxi sofa 3 seats relax

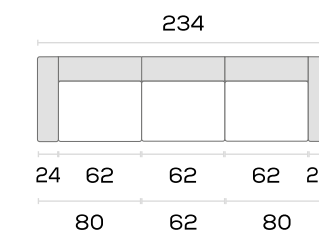

Sofá 204 cm. 2 asientos relax
204 cm. Sofa 2 seats relax

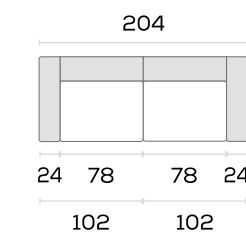

Sofá 172 cm. 2 asientos relax
172 cm. Sofa 2 seats relax

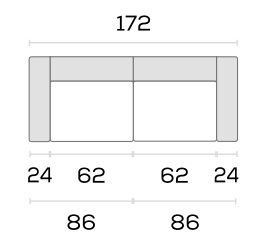

Sofá Fijo 204 cm. (1 módulo)
Fixed Sofa 204 cm. (1 module)

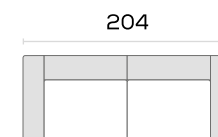

Sofá Fijo 172 cm. (1 módulo)
Fixed Sofa 172 cm. (1 module)

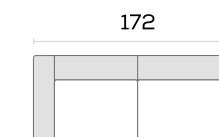

MÓDULOS / UNITS

Módulo 1 plaza sin brazo 78 cm.
78 cm. Module 1 seat without arm

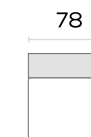

Módulo 1 plaza sin brazo 62 cm.
62 cm. Module 1 seat without arm

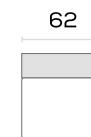

Medidas en centímetros
(+/- 5 cm.)

Measurements in centimeters
(+/- 5 cm.)



MOD.
SIDNEY





CARACTERÍSTICAS / CHARACTERISTICS



MOD. **SIDNEY**

ESTRUCTURA / Structure
Madera de pino Macizo 25 mm./ Tablero DM
Solid pine 25 mm. / MDF.

SUSPENSIÓN / Suspension
Bastidor de muelle zig-zag.
Zig-zag spring frame.

RESPALDOS Y BRAZOS / Backs and arms
Fibra de poliéster ahuecada y siliconada antialérgica de alta recuperación.
Hollow siliconised polyester fibre, hypoallergenic and high recovery.

ASIENTO / Seat
Espuma de poliuretano 35 kg/m³ + 5 cm. súpersoft recubierta de fibra acrílica.
Foam rubber 35 kg/m³ + 5 cm. super soft acrylic fibre cover.

DESENFUNDABLE / Removable loose covers
Asientos, brazos y respaldos / Asiento chaisnelongue NO desenfundable.
Seats, arms and backs. Chaise longue seat without removable covers.

RECUBRIMIENTO ESTRUCTURA / Structure coating
Espuma de poliuretano de 20 kg/m³ recubierta de fibra acrílica.
Foam rubber 20 kg/m³. Acrylic fibre cover.

MECANISMO / Mechanism
Relax motorizado y pistón para módulo chaisnelongue.
Motorised relax and piston for chaisnelongue unit.

PIE / Leg
Cromado. Chrome plated

TABLA DE PUNTOS / TABLE OF POINTS

	Denisse collection 1	Urban collection 2	Grupo 3 Group 3	Grupo 4 Group 4	Grupo 5 Group 5	Grupo 6 Group 6
COMPOSICIONES / COMPOSITIONS						
Comp. chaise relax 290 cm. / 290 cm. relax chaise composition	863	900	942	971	1004	1036
Comp. chaise relax 242 cm. / 242 cm. relax chaise composition	863	900	917	947	980	1012
Sofá relax 220 cm. 1 brazo puff almohadilla / 220 cm. relax sofa with 1 puff arm pad	658	685	719	731	761	778
Sofá relax 190 cm. 1 brazo puff almohadilla / 190 cm. relax sofa with 1 puff arm pad	658	685	703	715	745	761
Sofá Maxi relax 298 cm. 3 plazas 1 brazo puff almohadilla / 287 cm. 3 seaters relax maxi sofa with 1 puff arm pad	937	980	1025	1050	1083	1111
Sofá Maxi relax 250 cm. 3 plazas 1 brazo puff almohadilla / 257 cm. 3 seaters relax maxi sofa with 1 puff arm pad	937	980	1002	1027	1060	1087
Sofá relax 220 cm./ 220 cm. relax sofa	633	660	694	706	736	753
Sofá relax 190 cm./ 190 cm. relax sofa	633	660	678	690	720	736

MÓDULOS INDIVIDUALES / INDIVIDUAL UNITS						
Módulo 1 plaza 1 brazo puff almohadilla 110 cm. relax / 110 cm. 1 seater unit relax with 1 puff arm pad	-	-	369	375	390	398
Módulo 1 plaza 1 brazo puff almohadilla 94 cm. relax / 94 cm. 1 seater unit relax with 1 puff arm pad	-	-	361	367	382	390
Módulo 1 plaza sin brazo 78 cm. relax / 78 cm. 1 seater unit relax without arm	-	-	306	319	322	333
Módulo 1 plaza sin brazo 62 cm. relax / 62 cm. 1 seater unit relax without arm	-	-	299	312	315	326
Módulo chaise 100 cm. / 100 cm. chaise unit	-	-	267	277	292	305
Módulo chaise 86 cm. / 86 cm. chaise unit	-	-	257	268	283	296

Opcional sin coste: Brazo corto sofá 24 cm. (sin puffs).
Optional free: Arm short sofa 24 cm. (not puffs).

VALORACIÓN PUNTOS NETOS.
VALUATION NET POINTS.

MEDIDAS / MEASUREMENTS

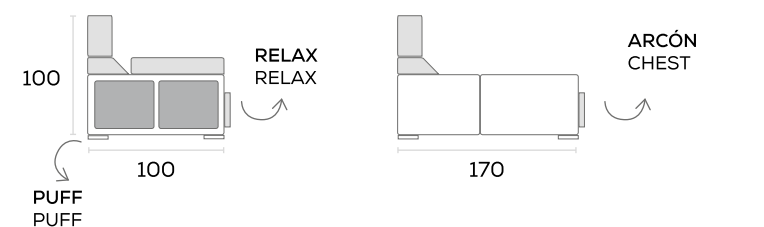

Este modelo lleva de serie arcón en módulo chaisnelongue + 2 relax eléctricos + 2 puff brazo corto.
This model has storage in the chaise longue unit with chest + 2 electric relax + 2 puff short arm as standard.

La mano de las composiciones siempre será vista de frente.
The direction of the compositions always be facing forward.

Este modelo se puede fabricar sin motor, se descontarán 59 puntos unidad.
This model can be made without motor, subtract 59 points/unit.

Cuando se quiera sin arcón, se descontarán 60 puntos.
This model can be made without storage, subtract 60 points/unit.



COMPOSICIONES / COMPOSITIONS

Comp. chaise 290 x 170 cm. motorizada o fija + 1 brazo puff + almohadilla (dcho. o izqdo) 290 x 170 cm. comp. chaise fixed or motorised + 1 puff arm + pad (right or left)

Comp. chaise 242 x 170 cm. motorizada o fija + 1 brazo puff + almohadilla (dcho. o izqdo) 242 x 170 cm. comp. chaise fixed or motorised + 1 puff arm + pad (right or left)

Sofá maxi 298 cm. motorizado o fijo + 1 brazo puff + almohadilla (dcho. o izqdo) 298 cm. maxi sofa fixed or motorised + 1 puff arm + pad (right or left)

Sofá maxi 250 cm. motorizado o fijo + 1 brazo puff + almohadilla (dcho. o izqdo) 250 cm. maxi sofa fixed or motorised + 1 puff arm + pad (right or left)

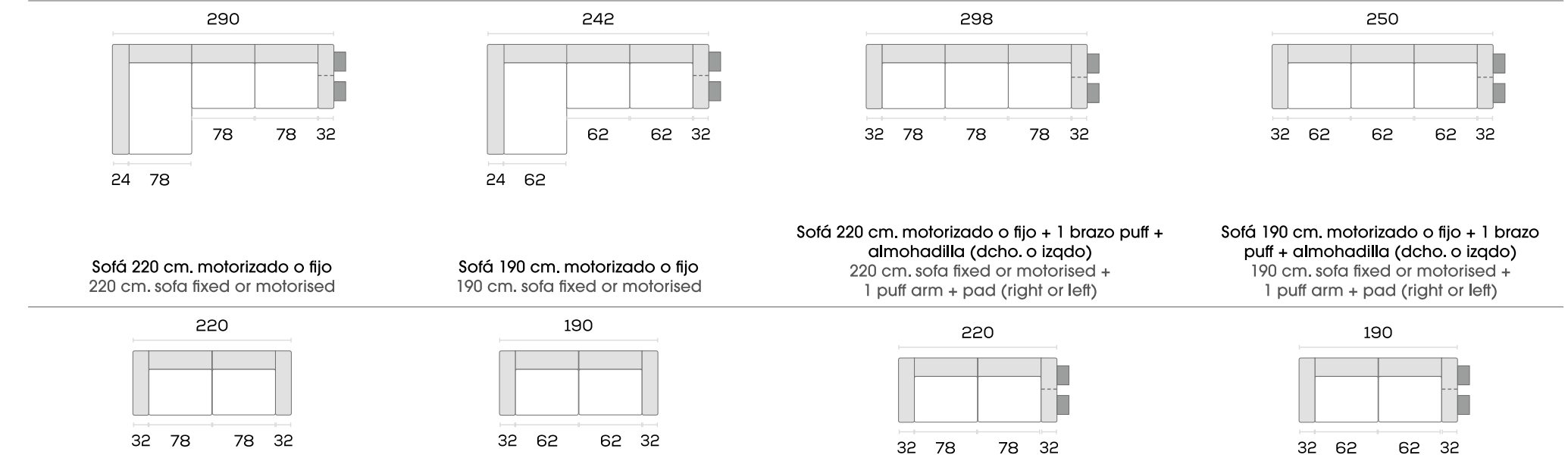

MÓDULOS / UNITS



Medidas en centímetros (+/- 5 cm.)
Measurements in centimetres (+/- 5 cm.)





CARACTERÍSTICAS / CHARACTERISTICS



MOD.
TEXAS

TABLA DE PUNTOS / TABLE OF POINTS

ESTRUCTURA / Structure
Madera pino macizo 25 mm. / tablero de partículas DM.
Solid pine 25 mm. / MDF.

SUSPENSIÓN / Suspension
Bastidor de muelle y cincha NEA.
Zig - zag spring frame.

RESPALDOS / Backs
Fibra de poliéster ahuecada y siliconada antialérgica de alta recuperación.
Hollow siliconised polyester fibre, hypoallergenic and high recovery.

DESENFUNDABLE / Removable loose covers
Asientos, brazos y repaldos. Asiento chaisse-longue NO desenfundable.
Seats, arms and backs. Chaisse-longue seat without removable covers.

ASIENTO / Seat
Espuma de Poliuretano de 35Kg/m³ + 5cms. Supersoft
Foam rubber 35 kg/m³ + 5 cm super soft acrylic fibre cover.

RECUBRIMIENTO ESTRUCTURA / Structure coating
Espuma de poliuretano de 20 kg/m³. Recubierta de fibra acrílica.
Foam rubber 20 kg/m³. Acrylic fibre cover.

BRAZO / Arms
Fibra de poliéster ahuecada y siliconada antialérgica de alta recuperación.
Hollow siliconised polyester fibre, hypoallergenic and high recovery.

MECANISMO / Mechanism
Relax motorizado.
Motorised relax.

PIE / Leg
Cromado. Chrome plated

Denisse collection 1	Urban collection 2	Grupo 3 Group 3	Grupo 4 Group 4	Grupo 5 Group 5	Grupo 6 Group 6
----------------------	--------------------	-----------------	-----------------	-----------------	-----------------

COMPOSICIONES / COMPOSITIONS						
Comp. Chaise 300 x 170 cm. Brazo puffs arcón / 300 x 170 cm. arm puffs chest	956	987	1034	1081	1114	1175
Com. Chaise 250 x 170 cm. Brazo puffs arcón / 250 x 170 cm. arm puffs chest	956	987	1011	1058	1090	1151
Sofá Maxi 300 cm. (3 relax) 2 brazos puffs arcón / 300 cm. (2 relax) 2 arms puffs chest	992	1024	1133	1175	1210	1267
Sofá Maxi 250 cm. (3 relax) 2 brazos puffs arcón / 250 cm. (3 relax) 2 arms puffs chest	962	992	1109	1154	1187	1245
Sofá 220 cm. (2 relax) 2 brazos puffs arcón / 220 cm. (2 relax) 2 arms puffs chest	751	774	798	826	852	890
Sofá 190 cm. (2 relax) 2 brazos puffs arcón / 190 cm. (2 relax) 2 arms puffs chest	732	755	780	812	836	874

MÓDULOS INDIVIDUALES / INDIVIDUAL UNITS						
Módulo Chaise 100 cm. / 100 cm. chaise unit	-	-	300	319	330	353
Módulo Chaise 94 cm. / 94 cm. chaise unit	-	-	292	310	321	344
Módulo 1 Plaza Sin Brazo 78 cm. relax / 78 cm. 1 seater unit relax without arm	-	-	335	349	358	377
Módulo 1 Plaza Sin Brazo 62 cm. relax / 62 cm. 1 seater unit relax without arm	-	-	329	342	351	371
Módulo 1 Plaza 110 cm. relax/brazo puffs arcón / 110 cm. 1 seater unit relax arms puffs chest	-	-	399	413	426	445
Módulo 1 Plaza 94 cm. relax/brazo puffs arcón / 110 cm. 1 seater unit relax arms puffs chest	-	-	390	406	418	437

VALORACIÓN PUNTOS NETOS.
VALUATION NET POINTS.

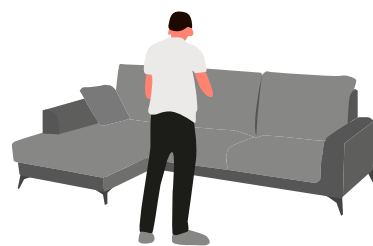

La mano de las composiciones siempre será vista de frente.
The direction of the compositions always be facing forward.

Este modelo lleva de serie 2 relax eléctricos; arcón chaisse-longue; brazo corto siesta reclinable con arcón y puff + 2 cojines de decoración. Cuando se quiera sin motor descontar 59 puntos.

Cuando se quiera sin arcón en modulo chaisse-longue descontar 60 puntos.

This model comes standard with 2 electric relaxes; chaisse-longue chest; short arm with reclining nap arm with chest and bean bag + 2 decoration cushions. When you want without an engine, discount 59 points.

When you want without a chest in a chaisse-longue module, discount 60 points.

Brazo almohada multiposición con arcón y puff.

Multi-position pillow arm with chest and puff.

Opcional: Brazo corto 24 cm sin coste.

Optional free: 24 cm. Short arm sofa.

MEDIDAS / MEASUREMENTS

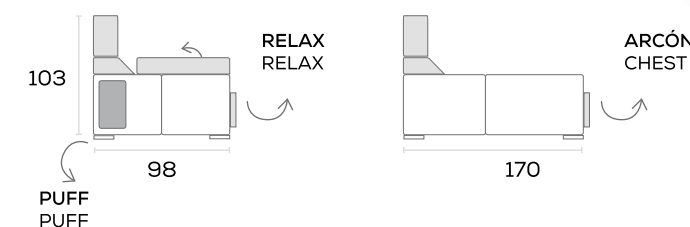

COMPOSICIONES / COMPOSITIONS

Comp. chaise 300 x 170 cm. motorizada o fija 300 x 170 cm. comp. chaise Comp. chaise 250 cm. motorizada o fija 250 cm. comp. chaise Módulo Chaise 108 x 170 cm. 108 x 170 cm. Chaise module Módulo Chaise 92 x 170 cm. 92 x 170 cm. Chaise module

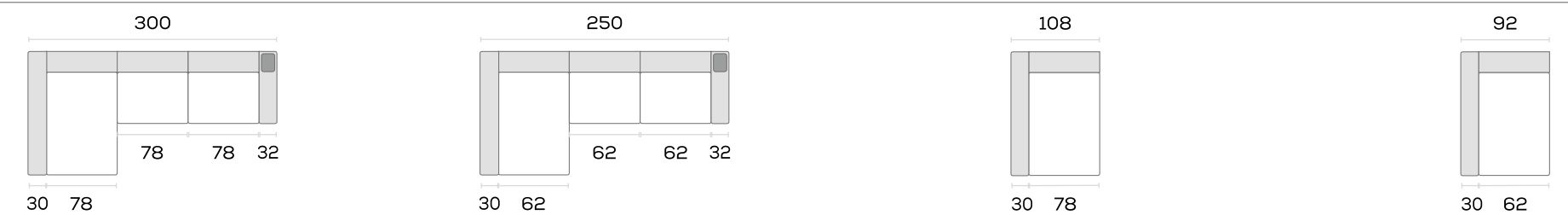

Sofá Maxi 300 cm. motorizado o fijo 300 cm. Maxi sofa fixed or motorised Sofá maxi 250 cm. motorizado o fijo 250 cm. Maxi sofa fixed or motorised sofá 220 cm. motorizado o fijo 220 cm. Sofa fixed or motorised sofá 190 cm. motorizado o fijo 190 cm. Sofa fixed or motorised



MÓDULOS / UNITS

Módulo 1 plaza 1 brazo 110 cm. 110 cm. Module 1 seat 1 arm Módulo 1 plaza 1 brazo 94 cm. 94 cm. Module 1 seat 1 arm Módulo 1 plaza 78 cm. 78 cm. Module 1 seat Módulo 1 plaza 62 cm. 62 cm. Module 1 seat

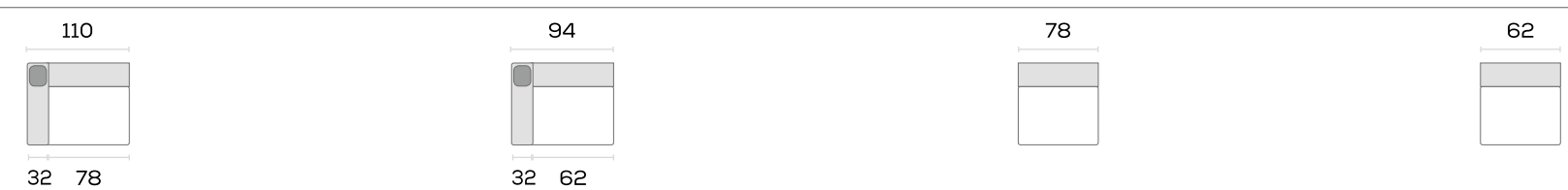

Medidas en centímetros (+/- 5 cm.) Measurements in centimetres (+/- 5 cm.)



MOD.
XIAN





CARACTERÍSTICAS / CHARACTERISTICS



TABLA DE PUNTOS / TABLE OF POINTS

ESTRUCTURA / Structure

Madera de pino macizo 25 mm. / Tablero partículas DM cubierta de poliuretano en diferentes grosores y densidades.

Solid pine 25 mm. / MDF cover of foam rubber in different thickness and densities.

SUSPENSIÓN / Suspension

Cincha NEA y bastidor de muelles zig-zag.

NEA webbing and zig-zag spring frame.

RESPALDOS / Backs

Fibra de poliéster ahuecada y siliconada antialérgica de alta recuperación.

Hollow siliconised polyester fibre, hypoallergenic.

DESENFUNDABLE / Removable loose covers

Asientos y respaldos.

Seats and backrests.

ASIENTO / Seat

Espuma de Poliuretano de 32 kg / m³.

32 kg / m³ polyurethane foam.

RECUBRIMIENTO ESTRUCTURA / Structure coating

Espuma de poliuretano 20 kg/m³.

Foam rubber 20 kg/m³.

PIE / Leg

Plata o grafito / Graphite or plated

Denisse collection 1	Urban collection 2	Grupo 3 Group 3	Grupo 4 Group 4	Grupo 5 Group 5	Grupo 6 Group 6
----------------------	--------------------	-----------------	-----------------	-----------------	-----------------

COMPOSICIONES / COMPOSITIONS						
Comp. Terminal 282 x 192 cm. / 282 x 192 cm. Terminal composition	669	693	735	765	799	818
Comp. Terminal 252 x 192 cm. / 252 x 192 cm. Terminal composition	635	660	705	732	766	786
Comp. Chaise 295 x 170 cm. / 295 x 170 cm. Chaise Composition	646	669	712	741	775	794
Comp. Chaise 250 x 170 cm. / 250 x 170 cm. Chaise Composition	622	646	688	717	752	770
Sofá Maxi 295 cm. / 295 cm. maxi sofa	634	657	700	729	763	782
Sofá Maxi 250 cm. / 250 cm. maxi sofa	587	610	653	682	716	735
Sofá 208 cm. / 208 cm.	368	382	404	420	439	453
Sofá 178 cm. / 178 cm.	335	348	373	392	411	418

MÓDULOS INDIVIDUALES / INDIVIDUAL UNITS						
Módulo 1 plaza sin brazo 87 cm. / 87 cm. Module 1 seat without arm	204	211	222	230	239	246
Módulo 1 plaza sin brazo 72 cm. / 72 cm. Module 1 seat without arm	185	193	205	215	224	227

VALORACIÓN PUNTOS NETOS.
VALUATION NET POINTS.



La mano de las composiciones siempre será vista de frente.
The direction of the compositions always be facing forward.

MEDIDAS / MEASUREMENTS

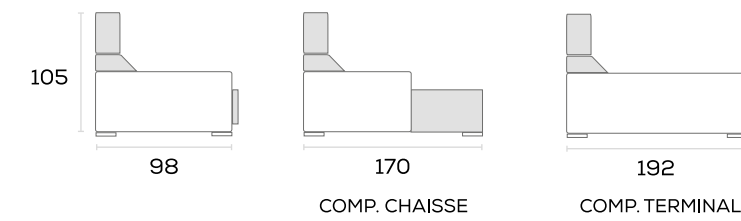

COMPOSICIONES / COMPOSITIONS

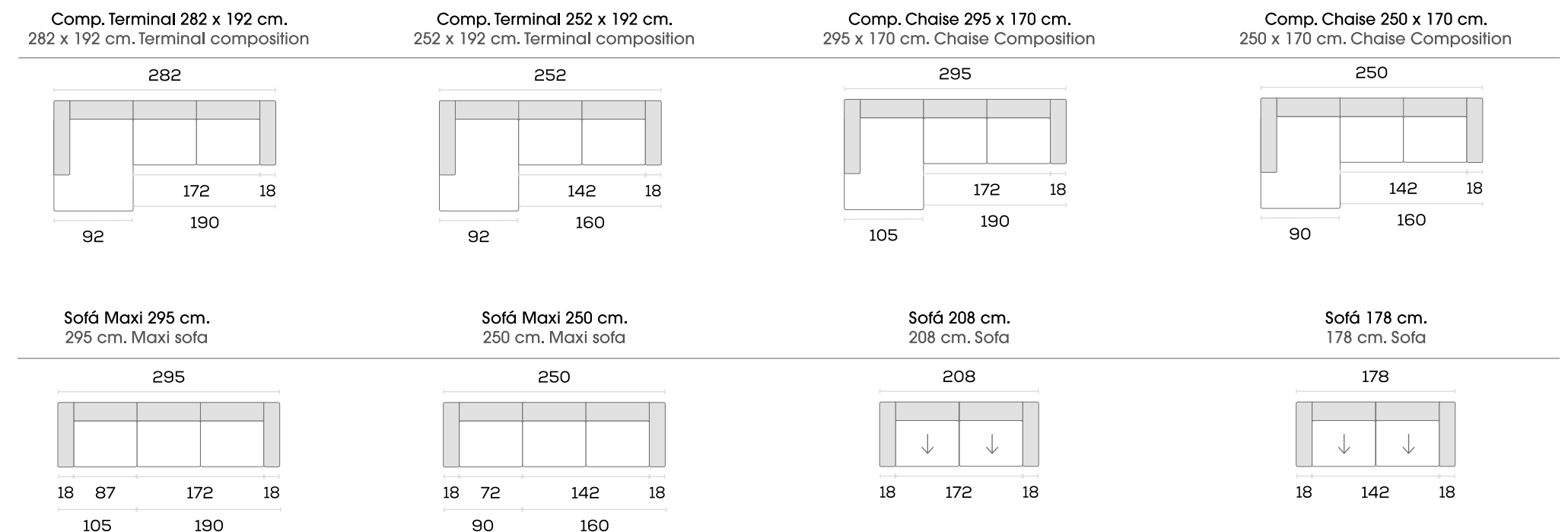

MÓDULOS / UNITS

Módulo 1 plaza 87 cm. / 87 cm. Module 1 seat

Módulo 1 plaza 72 cm. / 72 cm. Module 1 seat

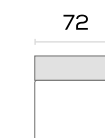
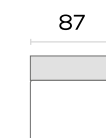

Medidas en centímetros (+/- 5 cm.)

Measurements in centimetres (+/- 5 cm.)

Condiciones de venta / Conditions of sale

PEDIDOS:

- Los pedidos recibidos serán entendidos como firme, no podrán ser anulados o modificados pasado 48 horas de la recepción del mismo.
- Todos los pedidos deberán enviarse por fax o email.
- La posición del módulo chaisse-longue siempre será visto de frente.
- Si de mutuo acuerdo se produjese devoluciones de mercancía, esta sufrirá una depreciación del 50% sobre el precio neto de la misma.
- IVA: el que corresponda irá cargado en factura.

TELAS:

- Las telas de cliente deberán enviarlas a fábrica a portes pagados, indicando cual es la cara correcta para su tapizado.
- Recomendamos no separen las piezas de un conjunto para su venta, ya que es prácticamente imposible el completarlos, por cambio de tonalidad en los tejidos.

CONDICIONES DE PRECIO Y ENTREGA:

- La mercancía se envía a portes pagados en todo el territorio peninsular español (excepto pedido de metrajes y cojines decorativos que no sean entregados con nuestro transportista, será enviado por agencia con portes a cargo del comprador).
- Rogamos que en el momento de recepcionar la mercancía firmen el albarán e indique la fecha de recepción de la misma, con el fin de poder llevar un mejor control y darles el mejor servicio.
- Gabe y García, SL, se reserva el derecho de modificar características de algunos componentes de los modelos comercializados por necesidades técnicas o comerciales.
- Tarifa cotizada en puntos.

CONDICIONES DE PAGO:

- No se servirá ningún pedido mientras se encuentre alguna factura pendiente de cobro.
- En caso de producirse impagados los gastos bancarios del impagado serán incrementados en sobre el nominal del efecto en concepto de gestión y tramitación del recobro.
- En caso de producirse impagados los gastos bancarios del impagado serán incrementados en sobre el nominal del efecto en concepto de gestión y tramitación del recobro.

RECLAMACIONES:

- Para la recogida de cualquier mercancía en nuestro distribuidor, es imprescindible que el transportista lleve orden de recogida y la mercancía debe estar perfectamente embalada. En caso de no cumplirse estas condiciones la mercancía no podrá ser recogida.
- Los gastos que origine cualquier reclamación, la cual no esté incluida en las condiciones de la garantía, correrá por cuenta del cliente.

JURISDICCIÓN COMPETENTE:

- En caso de litigio el cliente se someterá a la jurisdicción de los Tribunales de Écija (Sevilla), con renuncia expresa de su fuero propio.

ORDERS:

- The orders received will be understood as firm, they cannot be canceled or modified after 48 hours of receipt.
- All orders must be sent by fax or email.
- The position of the chaisse-longue module will always be seen from the front.
- If merchandise returns are mutually agreed, it will suffer a depreciation of 50% on its net price.
- VAT: the corresponding one charged on the invoice.

FABRICS:

- The client's fabrics must be sent prepaid to the factory, indicating the correct side of the fabric for upholstery.
- We recommend not separating the pieces of a set on sale as it is practically impossible to later complete them due to the change in tone of the fabrics.

PRICE AND DELIVERY CONDITIONS:

- The merchandise is shipped freight paid throughout the Spanish peninsular territory (except for ordering footage and decorative cushions that are not delivered with our carrier, it will be sent by agency with freight charge by the buyer).
- Please, at the time of receiving the merchandise, sign the delivery note and indicate the date of receipt of the merchandise, in order to be able to better control and provide the best service.
- Gabe y García, SL, reserves the right to modify characteristics of some components of the models sold for technical or commercial needs.
- Rate quoted in points.

PAYMENT CONDITIONS:

- No order will be served while an invoice is pending collection.
- In the event of unpaid bank expenses of the unpaid will be increased over the nominal amount of the effect for the management and processing of the recovery.
- Invoices whose amount is less than 300 euros, will be issued in a single draft of 30 days.

COMPLAINTS:

- For the collection of any merchandise in our distributor, it is essential that the carrier carries a collection order and the merchandise must be perfectly packaged. If these conditions are not met, the merchandise cannot be collected.
- The costs of any claim, which is not included in the warranty conditions, will be borne by the customer.

COMPETENT JURISDICTION:

- In the case of dispute, the client will be subject to the jurisdiction of the Courts of Écija (Seville) Spain, expressly waiving their own jurisdiction.





Since 1968

GABE TAPIZADOS / GABE & GARCÍA,S.L

P. Ind. El Limero Naves: 2-3-6-8

41400 ECIJA (Sevilla) SPAIN

Telf.: +34 954 831 495

info@gabetapizados.com

pedidos@gabetapizados.com

www.gabetapizados.com



@gabesofasspain

CIF: B-41856758



Producto fabricado en la UE